



Nexto PROFIBUS-DP Head User Manual

MU214608 Rev. G

September 27, 2022

No part of this document may be copied or reproduced in any form without the prior written consent of Altus Sistemas de Automação S.A. who reserves the right to carry out alterations without prior advice.

According to current legislation in Brazil, the Consumer Defense Code, we are giving the following information to clients who use our products, regarding personal safety and premises.

The industrial automation equipment, manufactured by Altus, is strong and reliable due to the stringent quality control it is subjected to. However, any electronic industrial control equipment (programmable controllers, numerical commands, etc.) can damage machines or processes controlled by them when there are defective components and/or when a programming or installation error occurs. This can even put human lives at risk. The user should consider the possible consequences of the defects and should provide additional external installations for safety reasons. This concern is higher when in initial commissioning and testing.

The equipment manufactured by Altus does not directly expose the environment to hazards, since they do not issue any kind of pollutant during their use. However, concerning the disposal of equipment, it is important to point out that built-in electronics may contain materials which are harmful to nature when improperly discarded. Therefore, it is recommended that whenever discarding this type of product, it should be forwarded to recycling plants, which guarantee proper waste management.

It is essential to read and understand the product documentation, such as manuals and technical characteristics before its installation or use. The examples and figures presented in this document are solely for illustrative purposes. Due to possible upgrades and improvements that the products may present, Altus assumes no responsibility for the use of these examples and figures in real applications. They should only be used to assist user trainings and improve experience with the products and their features.

Altus warrants its equipment as described in General Conditions of Supply, attached to the commercial proposals.

Altus guarantees that their equipment works in accordance with the clear instructions contained in their manuals and/or technical characteristics, not guaranteeing the success of any particular type of application of the equipment.

Altus does not acknowledge any other guarantee, directly or implied, mainly when end customers are dealing with third-party suppliers. The requests for additional information about the supply, equipment features and/or any other Altus services must be made in writing form. Altus is not responsible for supplying information about its equipment without formal request. These products can use EtherCAT® technology (www.ethercat.org).

COPYRIGHTS

Nexto, MasterTool, Grano and WebPLC are the registered trademarks of Altus Sistemas de Automação S.A.

Windows, Windows NT and Windows Vista are registered trademarks of Microsoft Corporation.

OPEN SOURCE SOFTWARE NOTICE

To obtain the source code under GPL, LGPL, MPL and other open source licenses, that is contained in this product, please contact opensource@altus.com.br. In addition to the source code, all referred license terms, warranty disclaimers and copyright notices may be disclosed under request.

Contents

1.	Introduction	1
1.1.	Nexto Series	1
1.2.	Innovative Features	2
1.3.	PROFIBUS	2
1.4.	NX5110 and NX5210	3
1.5.	Redundancy	3
1.5.1.	Network Redundancy	3
1.5.2.	Master Redundancy	4
1.6.	Information for Purchase	4
1.6.1.	Integral Items	4
1.6.2.	Product Code	4
1.6.3.	Related Products	4
1.7.	Documents Related to this Manual	5
1.8.	Visual Inspection	6
1.9.	Technical Support	6
1.10.	Warning Messages Used in this Manual	6
2.	Technical Description	7
2.1.	General Features	7
2.2.	Power Supply	8
2.3.	Physical Dimensions	9
2.4.	Compatibility with Other Products	9
2.4.1.	NX5110	9
2.4.2.	NX5210	10
2.4.3.	AL-3406	10
2.5.	Performance	10
2.5.1.	PROFIBUS- DP Head Response Time	10
2.6.	PROFIBUS-DP Head States	11
2.6.1.	NX5110 Module States	11
2.6.1.1.	Offline	11
2.6.1.2.	Active	11
2.6.1.3.	Error	11
2.6.2.	NX5210 Module States	11
2.6.2.1.	Offline	12
2.6.2.2.	Active	12
2.6.2.3.	Standby	12
2.6.2.4.	Error	12
2.7.	Hot Swap	12
2.7.1.	I/O Modules Hot Swap	12

2.7.2.	NX5110 Hot Swap	12
2.7.3.	NX5210 Hot Swap	13
2.8.	GSD File	13
2.9.	Supported Architectures	13
2.9.1.	Architecture A: Simple PROFIBUS-DP Network	14
2.9.2.	Architecture B: Redundant PROFIBUS-DP Network	15
2.9.3.	Architecture C: Redundant PROFIBUS-DP Network with Master's Redundancy	16
3.	Installation	17
3.1.	Electrical Installation	17
3.2.	Mechanical and Electrical Assembly	18
3.3.	Protection Circuit	18
3.4.	PROFIBUS-DP Network Installation	18
4.	Configuration	19
4.1.	Architecture Definition	19
4.2.	Bus Configuration	19
4.2.1.	Nexto Bus Limits	19
4.2.2.	Simple Network	20
4.2.3.	Redundant Network	23
4.3.	Module Parametrization	24
4.3.1.	PROFIBUS-DP Head Parameters	24
4.3.1.1.	Station Address	25
4.3.1.2.	Watchdog	25
4.3.1.3.	Hot Swap Mode	25
4.3.1.4.	Only Consists Declared Modules	26
4.3.1.5.	Status in Diagnose	26
4.3.1.6.	Channel Diagnostic	26
4.3.1.7.	Backplane Rack	26
4.3.1.8.	Manual Switchover (only NX5210)	26
4.3.2.	Modules Parameters	27
4.4.	PROFIBUS-DP Head's Informative and Configuration Menu	29
5.	Operation	31
5.1.	Sync/Freeze Mode	31
5.2.	NX5210 Redundancy	31
5.2.1.	General Features	31
5.2.2.	Switchover	31
5.2.2.1.	Módulo virtual NX9900	32
6.	Diagnostics	33
6.1.	PROFIBUS Diagnostics	33
6.1.1.	Standard Diagnostics	33
6.1.2.	Extended Diagnostics	34
6.1.2.1.	Device Diagnostics	34
6.1.2.2.	Module Diagnostics	35
6.1.2.3.	Channel Diagnostics	36
6.2.	Nexto PROFIBUS Diagnostics	36
7.	Maintenance	41
7.1.	Module Diagnostics	41
7.1.1.	Graphical Display	41
7.1.2.	One Touch Diag	41

7.1.3.	Diagnostics LEDs	43
7.1.3.1.	DG (Diagnostic)	43
7.1.3.2.	WD (Watchdog)	44
7.1.4.	WEB Diagnostics	44
7.2.	Preventive Maintenance	47

1. Introduction

This manual aims to guide the user during products selecting stages for certain application, as well as at installation, programming and maintenance related to the product PROFIBUS-DP Head NX5x10, which is part of the Nexto Series of programmable controllers.

1.1. Nexto Series

Nexto Series is a powerful and complete series of Programmable Controllers (PLC) directed to satisfy the necessities of small and middle-sized applications, as well as high level applications. The series has many features and brings the best cost-benefit both for great process automations and machinery automations. Nexto Series is based in a modular system which allows flexibility between performance and cost.

Nexto Series architecture has a great variety of input and output modules. These modules combined with a powerful 32 bits processor and a high speed bus based on Ethernet, fit to several application kinds as high speed control for small machines, complex distributed processes, redundant applications and systems with a great number of I/O as building automation. Furthermore, Nexto Series has modules for motion control, communication modules encompassing the most popular field networks among other features.

Nexto Series uses an advanced technology in its bus, which is based on a high speed Ethernet interface, allowing input and output information and data to be shared between several controllers inside the same system. The system can be easily divided and distributed throughout the whole field, allowing the use of bus expansion with the same performance of a local module, turning possible the use of every module in the local frame or in the expansion frames with no restrictions. For interconnection between frames expansions a simple standard Ethernet cable is used.



Figure 1: Nexto Series - Overview

1.2. Innovative Features

Nexto Series brings to the user many innovations regarding utilization, supervision and system maintenance. These features were developed focusing a new concept in industrial automation.



One Touch Diag: One Touch Diag is an exclusive feature that Nexto Series brings to PLCs. With this new concept, the user can check diagnostic information of any module present in the system directly on CPU's graphic display with one single press in the diagnostic switch of the respective module. OTD is a powerful diagnostic tool that can be used offline (without supervisor or programmer), reducing maintenance and commissioning times.

ETD – Electronic Tag on Display: Another exclusive feature that Nexto Series brings to PLCs is the Electronic Tag on Display. This new functionality brings the process of checking the tag names of any I/O pin or module used in the system directly to the CPU's graphic display. Along with this information, the user can check the description, as well. This feature is extremely useful during maintenance and troubleshooting procedures.

DHW – Double Hardware Width: Nexto Series modules were designed to save space in user cabinets or machines. For this reason, Nexto Series delivers two different module widths: Double Width (two backplane rack slots are required) and Single Width (only one backplane rack slot is required). This concept allows the use of compact I/O modules with a high-density of I/O points along with complex modules, like CPUs, fieldbus masters and power supply modules.



iF Product Design Award 2012: Nexto Series was the winner of iF Product Design Award 2012 in industry + skilled trades group. This award is recognized internationally as a seal of quality and excellence, considered the Oscars of the design in Europe..

1.3. PROFIBUS

Fieldbus networks usage as communication link between Central Processing Units of automation and field devices grow popular every day. Experience has shown that usage of network technologies brings many benefits to installation, configuration and maintenance of wirings in comparison with previous technology. In field networks, only one pair of wires is needed to transmit information, such as input or output data, parameters, diagnostics, programs or power for field devices.

Field networks have been used for quite some time, however the first ones were proprietary and incompatible with each other, with high costs for configuration or interfacing between equipments of different manufacturers. New networks offer open standards, which dismisses projects of complex interfaces. Open systems allow the end user to freely choose the best solution for his application between a wide range of products.

PROFIBUS is the leading fieldbus network in Europe, with great acceptance in the rest of the world. Its application areas include manufacturing, process control and building automation.

PROFIBUS is an open fieldbus, standardized in Europe as EN50170, and internationally recognized as IEC61158 and IEC61784. The most important world manufacturers of automation technology offer PROFIBUS interface for its devices.

1.4. NX5110 and NX5210

The PROFIBUS Fieldbus Heads NX5110 and NX5210 are modular slave type network devices of the Nexto Series. They enable the access of remote I/O modules through the PROFIBUS-DP fieldbus.

Both have the same physical features, differing only externally through the information in the front panel, and their information tags at the bottom.

The fundamental difference between the two heads is NX5210's capacity for head redundancy, which works together with the second NX5210 in the bus to increase availability.



Figure 2: NX5110 Module



Figure 3: NX5210 Module

1.5. Redundancy

There are two types of redundancies that can be configured for NX5110 and NX5210 module:

- [Network Redundancy](#), only available for NX5210.
- [Master Redundancy](#)

1.5.1. Network Redundancy

In redundant networks, each slave device has two redundant interfaces, NX5210, forming a double network, connected to two modules masters, NX5001.

Fieldbus network redundancy is a vital feature where high reliability is required. NX5001 network interface is the solution for this type of application, being used in pairs. In this type of redundancy, the slave device, by having two connections, chooses through which network it will receive and transmit its data. Examples of redundant devices are Altus' PROFIBUS network heads NX5210, PO5063V5 and PO5065.

Each pair of redundant heads controls a bus of Nexto or Ponto Series I/O modules, alternately. One of the redundant heads is communicating through the network (active) and the other one is in standby. The standby head can take control of the bus if there is a failure in the network of the active head or in its hardware. This change is automatic and transparent to users, keeping the system in operation in case of failure in one of the networks.

At the CPU that controls the network, the NX5001 interfaces manage incoming data from the network, so only the inputs from the active head are copied to the CPU's variables, while inputs of the standby head are ignored. The outputs are sent to the two heads (active and standby), but only the active head writes in the output modules.

The CPUs are informed through NX5001 interfaces which head is active on each network node, and if there is any defective device. In this type of network, hot reconfiguration is allowed, reconfiguring one network while the other remains in operation and vice-versa.

It should be noted that the network can continue operating normally when there are defects in some heads connected to PROFIBUS A network, as well as defects in other heads connected to PROFIBUS B network, as long as both heads from the same group of remote I/O have not failed. In this case, communication with the system of remote I/O is partly distributed between network A and network B.

1.5.2. Master Redundancy

Master redundancy is characterized by the existence of two PROFIBUS-DP NX5001 masters on the same network, where one NX5001 acts as active master and the other as passive master.

PROFIBUS masters in active mode establish connection with the slaves. Its network operation status is OPERATE.

Enabled PROFIBUS masters in passive mode are used to test the PROFIBUS transmission and reception circuits, in order to avoid failures. Passive masters communicate only with active masters. Its operation state is STOP.

Further details regarding the master states can be found in the PROFIBUS Network Utilization - MU299026.

Regarding its configuration, both masters receive the same bus configuration and the PROFIBUS slaves' configuration.

The active network master has the address configured by the user in the MasterTool IEC XE programmer. The passive master connects to the network through another address. The passive master's address is active master's address subtracted by one. In case the active master's address is zero, the passive master's address will be set to 125.

The passive network master's address is transparent to the user, so there's no specific configuration needed. The NX5001 module calculates and takes this address when it becomes the PROFIBUS network passive master.

It's up to the Nexto Series CPU to define if the PROFIBUS-DP NX5001 master acts as passive or active master.

For further details regarding the PROFIBUS-DP NX5001 insertion in the series redundancy context, see Nexto Series CPUs Utilization Manual (MU214605), chapter Redundancy with NX3030 CPU.

1.6. Information for Purchase

1.6.1. Integral Items

The product package contains the following items:

- NX5110 or NX5210 module
- 6-terminal block with fixing

1.6.2. Product Code

The following codes shall be used for product purchase:

Code	Description
NX5110	PROFIBUS-DP Head
NX5210	PROFIBUS-DP Redundant Head

Table 1: Module Names

1.6.3. Related Products

The following products must be acquired separately whenever necessary:

Code	Description
NX9010	8-Slot Backplane Rack (No Hot Swap)
NX9000	8-Slot Backplane Rack
NX9001	12-Slot Backplane Rack
NX9002	16-Slot Backplane Rack
NX9003	24-Slot Backplane Rack

Code	Description
NX3004	CPU, 1 Ethernet port, 1 serial channel, remote rack expansion support and power supply integrated
NX3005	CPU, 1 Ethernet port, 1 serial channel, remote rack expansion support, power supply integrated and user web pages support
NX3010	High-speed CPU, 1 Ethernet port, 2 serial channels, memory card interface and remote rack expansion support
NX3020	High-speed CPU, 2 Ethernet ports, 2 serial channels, memory card interface and remote rack expansion support
NX3030	High-speed CPU, 2 Ethernet ports, 2 serial channels, memory card interface, remote rack expansion and redundancy support
NX9404	6-terminal connector with fixing
AL-2601	PROFIBUS Connector
AL-2602	PROFIBUS Terminator Connector
AL-2605	Terminator with Power Supply Diagnostic
AL-2303	PROFIBUS cable
AL-2431	FOCUS/ PROFIBUS Optical Repeater
AL-2432	FOCUS/ PROFIBUS Optical Repeater with Two Ports
AL-2433	PROFISwitch – Coupler for Redundant Profibus Network
NX5001	PROFIBUS-DP Master Module
PO4053	PROFIBUS-DP Master Interface
AL3406	PROFIBUS-DP Master Interface
MT8500	MasterTool IEC XE

Table 2: Related Products

Notes:

AL-2601: The connector for PROFIBUS-DP network is a connector type DB9 with standardized pinout according to EN 50170 and without termination. It is suitable for connection to PROFIBUS-DP devices mounted on intermediate positions in the PROFIBUS-DP network, i.e. physically not mounted at the ends of the network. This connector has input and output connection of the cable network, enabling disconnection be done without disrupting the continuity of the physical network.

AL-2602: PROFIBUS-DP terminator connector is a connector type DB9 with standardized pinout according to EN 50170 and termination. It is suitable for connection to PROFIBUS-DP devices mounted on the ends of the physical network (beginning and end).

AL-2605: The terminator with diagnosis of font is used in the extremes of redundant networks, where is needed to make the exchange of devices without losing the endings.

AL-2303: Cable for data communication on PROFIBUS-DP network.

AL-2431 and AL-2432: Optical repeaters for interconnection between any PROFIBUS-DP equipment through optical fiber. The module AL-2432 has redundancy of optical transmission by adding increased availability to the system.

AL-2433: The AL-2433 adapter enables the interconnection between non-redundant PROFIBUS-DP slave devices in a redundant PROFIBUS-DP network with AL-3406, PO4053 or NX5001 masters.

NX5001: PROFIBUS-DP Master – Nexto Series.

PO4053: PROFIBUS-DP Master – Ponto Series.

AL3406: PROFIBUS-DP Master – AL Series.

MT8500: MasterTool IEC XE is available in four different versions: LITE, BASIC, PROFESSIONAL and ADVANCED. For more information, please consult the MasterTool IEC XE User Manual - MU299609.

1.7. Documents Related to this Manual

For additional information about Nexto Series, you can consult other documents (manuals and technical data) beyond this one. These documents are available in its last review on www.altus.com.br/en/.

Each product has a document called Technical Characteristics (CE), with the list of features of the product in question. Additionally, the product may have User Manuals (manuals' codes are mentioned at CEs of each product).

For example, the NX2020 module has all the usage and purchase characteristics information in your CE. On the other hand, in addition to the CE, the NX5001 has a user manual.

It is recommended to consult the following documents as a source of additional information:

- Technical Characteristics of each product
- Nexto Series User Manuals
- MasterTool Programming Manual for the Nexto Series
- PROFIBUS-DP Master NX5001 User Manual

1.8. Visual Inspection

Before resuming the installation process, it is advised to carefully visually inspect the equipment, verifying the existence of transport damage. Verify if all parts requested are in perfect shape. In case of damages, inform the transport company or Altus distributor closest to you.

CAUTION

Before taking the modules off the case, it is important to discharge any possible static energy accumulated in the body. For that, touch (with bare hands) on any metallic grounded surface before handling the modules. Such procedure guarantees that the module static energy limits are not exceeded.

It's important to register each received equipment serial number, as well as software revisions, in case they exist. This information is necessary, in case the Altus Technical Support is contacted.

1.9. Technical Support

For Altus Technical Support contact in São Leopoldo, RS, call +55 51 3589-9500. For further information regarding the Altus Technical Support existent on other places, see <https://www.altus.com.br/en/> or send an email to altus@altus.com.br.

If the equipment is already installed, you must have the following information at the moment of support requesting:

- The model from the used equipments and the installed system configuration
- The product serial number
- The equipment revision and the executive software version, written on the tag fixed on the product's side
- CPU operation mode information, acquired through MasterTool IEC XE
- The application software content, acquired through MasterTool IEC XE
- Used programmer version

1.10. Warning Messages Used in this Manual

In this manual, the warning messages will be presented in the following formats and meanings:

DANGER

Reports potential hazard that, if not detected, may be harmful to people, materials, environment and production.

CAUTION





Reports configuration, application or installation details that must be taken into consideration to avoid any instance that may cause system failure and consequent impact.

ATTENTION

Identifies configuration, application and installation details aimed at achieving maximum operational performance of the system.

2. Technical Description

2.1. General Features

	NX5110	NX5210
Module Type	PROFIBUS-DP Fieldbus Head	PROFIBUS-DP Fieldbus Redundant Head
Communication Protocol	PROFIBUS-DP, standard EN50170	
Sync/Freeze Support	Yes	
Backplane Rack Occupation	2 Sequential Positions	
Maximum Number of Modules	22	20
Input Capacity	240 input bytes	238 data bytes + 2 bytes regarding the head status
Output Capacity	240 data bytes	238 data bytes + 2 bytes of User Commands
PROFIBUS-DP Baud Rate	Automatic Baud rate detection from 9.6 to 12000 kbits/s	
Ethernet Port Baud Rate	10/100 Mbps	
Status and Diagnostics Indication	Display, web page and LEDs	
Network Redundancy Support	No	Yes
Hot Swap Support	No	Yes
I/O Hot Swap Support	Yes	
GSD File	ALT_0EDD.GSD ALNJ0EDD.GSD	ALT_0EDE.GSD
One Touch Diag (OTD)	Yes	
Electronic Tag on Display (ETD)	Yes	
Standards and Certifications	<p>Standard PROFIBUS Europea EN 50170 IEC 61131-2:2003, chapter 8 and 11 CE – 2011/65/EU (RoHS), 2014/35/EU (LVD) and 2014/30/EU (EMC) UL Listed - UL61010-1 (file E473496) DNV Type Approval – DNV-CG-0339 (TAA000013D) EAC - CU TR 004/2011 (LVD) and CU TR 020/2011 (EMC)</p> <div style="text-align: center;">     </div>	
Isolation		
PROFIBUS Interface to Logic	1000 Vac / 1 minute	
PROFIBUS Interface to Earth Protection ⊕	1000 Vac / 1 minute	
Logic to Earth Protection ⊕	1250 Vac / 1 minute	
Input Voltage	19.2 to 30 Vdc	
Max Input Current (in-rush)	30 A	
Max Input Current	1.4 A	
Max Current Provided to the Bus	3 A	
Dissipation	5 W	
IP Level	IP 20	
Operating Temperature	0 to 60 °C	

	NX5110	NX5210
Storage Temperature	-25 to 75 °C	
Operation and Storage Relative Humidity	5 to 96 %, non-condensing	
Conformal Coating	Yes	
Module dimensions (W x H x D)	36.00 x 114.63 x 115.30 mm	
Package dimensions (W x H x D)	44.00 x 122.00 x 147.00 mm	
Weight	200 g	
Weight with Package	250 g	

Table 3: General Features

Notes:

Maximum Number of Modules: The maximum number of modules is related to greater backplane rack available in Series Nexto, with 24 positions, two positions are occupied by the NX5110 module, allowing the use of a maximum of 22 modules in this frame. There are still other limits that are to be taken into consideration, such as the consumption of each I/O module and also the number of bytes of input and output that each module has. In this way, this limit may be reduced in the light of these other requirements.

Input Capacity: Each PROFIBUS-DP remote’s ability to convey the master module the limit of 240 bytes of input, thus it is necessary to consult the user Manual of the Nexto PROFIBUS-DP Head -MU214608 the number of bytes of each module entry consumes. For example, the HSC NX1001 module (module NX1001 counter mode enabled) has 16 bytes of input.

Output Capacity: Each PROFIBUS-DP remote has the ability to receive the master module the limit of 240 bytes of output, thus it is necessary to consult the user Manual of the Nexto PROFIBUS-DP Head -MU214608 the number of bytes of each module output consumes. For example, the HSC NX1001 module (module NX1001 counter modes enabled) has 11 bytes of output.

Baud rate: The baud rate is detected in the following communication speeds: 9.6 kbits/s, 19.2 Kbit/s, 93.75 Kbit/s, 187.5 Kbit/s, 500 Kbit/s, 1500, 3000 Kbit/s Kbit/s Kbit/s 6000 and 12000 Kbit/s.

Isolation: In order to identify the different circuits and component sets that have isolation on the product, the term logic is the name given the internal interfaces as memories, and interfaces with the rack.

Max Current Provided to the Bus: The modules NX5110 and NX5210 have an integrated power supply that can provide to the bus 3 A of current to power the I/O modules.

Conformal Coating: The coating of electronic circuitry protects the internal parts of the product against humidity, dust and other harsh elements to electronic circuits.

ATTENTION

NX5110 and NX5210 modules don’t have network terminations, therefore external terminator modules are necessary.

2.2. Power Supply

	NX5110	NX5210
Nominal Input Voltage	24 Vdc	
Maximum Output Power	15 W	
Maximum Output Current	3 A	
Input Voltage	19.2 to 30 Vdc	
Maximum Input Current (in-rush)	30 A	
Maximum Input Current	1.4 A	
Maximum input voltage interruption	10 ms	
Isolation		
Input to Output	1000 Vac / 1 minute	
Input to Earth Protection ⚡	1500 Vac / 1 minute	
Input to Functional Earth ⚡	1500 Vac / 1 minute	

	NX5110	NX5210
Wire Gauge	0.5 mm ²	
Reverse polarity protection	Yes	
Internal Resettable fuse	Yes	
Short circuit protection on the output	Yes	
Overcurrent Protection	Yes	

Table 4: Power Supply features

2.3. Physical Dimensions

Dimensions in mm.

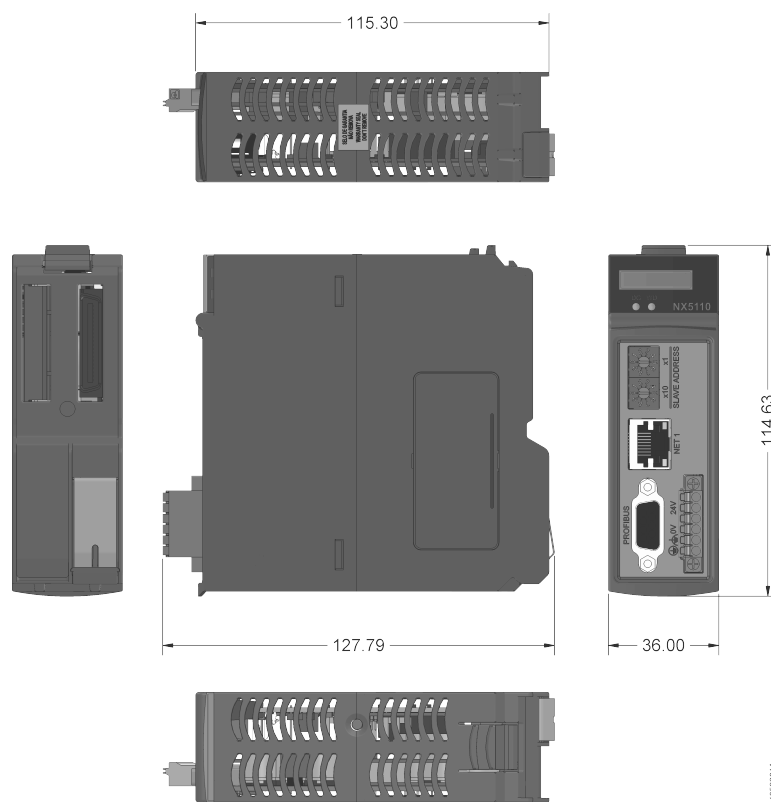

Figure 4: NX5x10 Physical Dimensions

2.4. Compatibility with Other Products

2.4.1. NX5110

The following table provides information concerning the compatibility between the NX5110 module with the programming tool MasterTool IEC XE and other Nexto Series Modules.

	Software Version	Product Revision
NX5001	1.2.0.0 or above	AG
MT8500	2.01	AQ

Table 5: Compatibility NX5110

2.4.2. NX5210

The following table provides information concerning the compatibility between the NX5210 module with the programming tool MasterTool IEC XE and other Nexto Series Modules.

	Software Version	Product revision
NX5001	1.2.0.0 or above	AG
MT8500	2.01	AQ

Table 6: Compatibility NX5210

2.4.3. AL-3406

When using AL-3406 on PROFIBUS networks composed exclusively by Nexto Series slaves, the parameter Watchdog Control must be configured with a minimum value of 2000 ms (2 seconds).

2.5. Performance

2.5.1. PROFIBUS- DP Head Response Time

Response time is the time between the detection of an input variation and the change of the corresponding output. NX5110 and NX5210 heads have the same response time.

The response time of a remote I/O system depends on internal delays, on the network that connects it to the master and on the network control program's processing time.

To calculate the maximum response time, the following formula is recommended:

Maximum Response Time for Input Reading

$$= InputModuleUpdateTime + PROFIBUSHeadCycleTime + PROFIBUSNetworkScan \quad (1)$$

Maximum Response Time for Output Writing

$$= OutputModuleUpdateTime + PROFIBUSHeadCycleTime + PROFIBUSNetworkScan \quad (2)$$

Input and Output Modules' Update Time: this time depends on the I/O module and it is specified in its Technical Characteristics document.

PROFIBUS Head Cycle Time: PROFIBUS Head cycle time is 6 ms, which is the necessary time to perform the read and write of I/O modules.

PROFIBUS Network Scan: PROFIBUS network scan time must be evaluated at the network's Master. The scan time depends on the quantity of octets configured in the network. The Master's program processing time must be considered, including the application execution time and its operational system, and the time it takes for the data to reach the CPU. For instance, when the Baud Rate is 12 Mbps, the scan time is 1 ms.

Example

A remote bus with one 16 digital inputs (NX1001) module and one 16 digital outputs module (NX2001). In these conditions, let's consider an application that operates an output point (NX2001) and it is connected to an input in the module NX1001, we will observe the following maximum time to detect an alteration of the input in the main CPU, considering also the PROFIBUS-DP network at 12 Mbps.

PROFIBUS-DP Network Scan: 1 ms

NX1001 Update = 2 ms

NX2001 Update = 2 ms

PROFIBUS Head Cycle = 6 ms

Application Program Cycle Time = 20 ms

Maximum Response Time

$$= \text{DigitalInputUpdateTime} + \text{PROFIBUSHeadCycle} + \text{PROFIBUSNetworkScan} + \text{ApplicationProgramCycleTime} \quad (3)$$
$$+ \text{PROFIBUSNetworkScan} + \text{PROFIBUSHeadCycle} + \text{DigitalOutputUpdateTime} \quad (4)$$

Maximum Response Time = 2 ms + 6 ms + 1 ms + 20 ms + 1 ms + 6 ms + 2 ms

Application Program Cycle Time: Defined by the interval time of the application program running in the Master bus CPU. In Nexto Series' case, it's the MainTask Interval.

2.6. PROFIBUS-DP Head States

It is important to know the states in which NX5110 and NX5210 heads operate so the user can understand how it works. Each state is activated distinctly and has unique features, allowing the head's operation.

2.6.1. NX5110 Module States

NX5110 head operates in one of these three states:

- Offline (OFF)
- Active (ACT)
- Error (ERR)

2.6.1.1. Offline

In this state, the head doesn't Exchange data with the Master, nor does it act upon I/Os or monitors Nexto bus. The state happens since the head is powered until it receives proper configuration and parameters from the Master, or when there's no communication with the Master. It can change to Active when the head is properly configured and parameterized by the Master, or to Error when some problem is detected.

2.6.1.2. Active

In this state, the head exchanges data with the Master, acts upon I/O modules and monitors Nexto bus. It can change to Offline when it loses communication with the Master, or to Error when some problem is detected.

2.6.1.3. Error

In this state, the head loses read and write access to Nexto bus and it doesn't update I/Os sent by the Master. The head gets into this state when the hot swap is disabled and some inconsistency is detected on the bus (absent modules, etc.), showing further details of the error in the diagnostics area (see chapter [Diagnostics](#)). To leave this state, it is necessary to restart the head (power reset or a hot swap).

2.6.2. NX5210 Module States

NX5210 head operates in one of these four states.

- Offline (OFF)
- Active (ACT)
- Standby (SBY)
- Error (ERR)

2.6.2.1. Offline

In this state, the head doesn't Exchange data with the Master, nor does it act upon I/Os or monitors Nexto bus. The state happens since the head is powered until it receives proper configuration and parameters from the Master, or when there redundant slave has no communication with the Master. It can change to Active or Standby, considering that the first head that is configured will either go to Active or Error when some problem is detected.

2.6.2.2. Active

In this state, the head has exclusive access to the bus, where it exchanges data with the Master, acts upon I/O modules and monitors Nexto bus. This is the head that exchanges valid data with the Master. It can change to Standby in case of a Switchover or to Error when some problem is detected. If the redundant slave loses its communication with the Master, it goes to Offline.

2.6.2.3. Standby

In this state, the head doesn't have bus read and write access. Even so, it is receiving and sending data to the PROFIBUS network Master and monitoring failures in the Active head. Through virtual redundancy module NX9900, the Standby head indicates that the data should not be considered valid by the application. It can change to Active state in case of a Switchover, to Offline state if the redundant slave loses communication with the Master or to Error when some problem is detected.

2.6.2.4. Error

In this state, the head loses read and write access to Nexto bus and it doesn't update I/Os sent by the Master. The head gets into this state in two situations:

- When the hot swap is disabled and some inconsistency is detected on the bus (absent modules, etc.)
- When the PROFIBUS address (set by the front panel switches) is different from the one set for the Active head.

In these situations, further details on the error are presented in the diagnostics area (see chapter [Diagnostics](#)). To leave this state, it is necessary to restart the head (power reset or a hot swap).

2.7. Hot Swap

This feature enables the replacement of modules while the bus is energized, making maintenance in case of module failure easier.

2.7.1. I/O Modules Hot Swap

Both NX5110 and NX5210 allow Hot Swap of its I/O modules. It is recommended consulting Nexto Series User Manual (MU214600).

2.7.2. NX5110 Hot Swap

It is not possible to hot swap NX5110, because it will consequently remove the bus power supply, making the I/O modules shut down.

ATTENTION

If the NX5110 module is removed, the last input information sent to the Master will be frozen.

2.7.3. NX5210 Hot Swap

It is possible to hot swap the redundant Head NX5210 when there's a redundant slave. For it to be possible, the remaining head must be in Primary Online State. This way, there's no need to shut down the power source and the replacement of the head won't influence I/O devices.

ATTENTION

If Both NX5210 heads are removed, the last input information sent to the Master will be frozen.

2.8. GSD File

All PROFIBUS-DP devices have a file that defines its limits and configuration possibilities. NX5110 and NX5210 heads use different files, being ALT_0EDD.GSD and ALNJ0EDD.GSD for NX5110 and ALT_0EDE.GSD for NX5210. ALNJ0EDD.GSD is to be used with Nexto Jet series' modules and head NX5110. Altus provides definition these files so that the modules can be added in a PROFIBUS-DP network. These files are in English. Also related to the GSD files are three image files (DIB extension) that help identifying the correct head during PROFIBUS network assembly in the Master's configurator tool.

Files ALT_0EDD.GSD, ALNJ0EDD.GSD, NX5110_S.DIB, NX5110_R.DIB, NX5110_D.DIB, ALT_0EDE.GSD, NX5210_S.DIB, NX5210_R.DIB and NX5210_D.DIB are available at the webpage <http://www.altus.com.br/en/> and also are available in MasterTool IEC XE.

These files facilitate interoperability in the PROFIBUS network of devices from different vendors, and also contain device features and other information such as quantity and types of modules, diagnostic messages, bus parameterization and baud rate.

GSD files must be used in the network Master's configuration through a special program that imports such files and require that the user picks his modules options, as shown in the figure below.

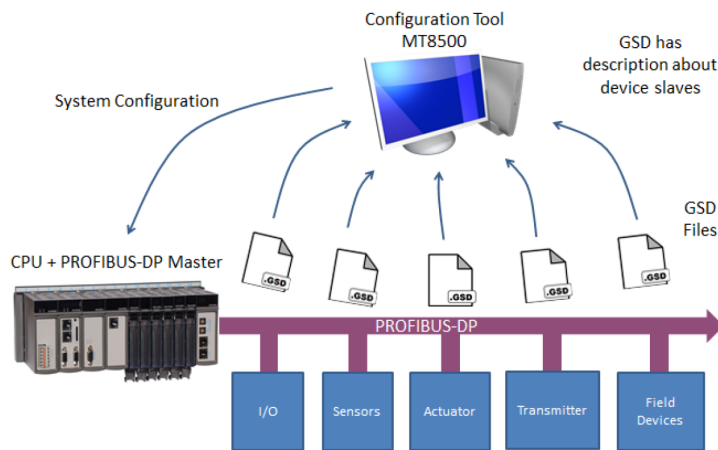

Figure 5: Configuration through GSD Files

2.9. Supported Architectures

Nexto Series brings to the user MasterTool IEC XE software, a powerful tool that presents a complete interface to program all modules of the series.

ATTENTION

No additional software is required to parameterize the PROFIBUS network's modules. No extra cable is necessary as well. All configuration and parameters are made in MasterTool IEC XE and sent to the PROFIBUS-DP Master NX5001 through Nexto CPU.

2. TECHNICAL DESCRIPTION

The PROFIBUS network configuration is made in MasterTool IEC XE, where all device configuration files (.GSD) connected to the Master NX5001 are required.

ATTENTION

NX5001 GSD file, as well as Nexto Series' and Ponto Series' remotes are already installed in MasterTool IEC XE, ready to be used.

This section presents the possible PROFIBUS network architectures, using Nexto Series NX5001 (Master), NX5110 and NX5210 (heads).

2.9.1. Architecture A: Simple PROFIBUS-DP Network

The PROFIBUS-DP network configuration allows simple connection between a master and slave devices through a single network. The following figure illustrates this connection by using Nexto Series PROFIBUS-DP Master NX5001, however, this same link can be applied with other PROFIBUS-DP master.

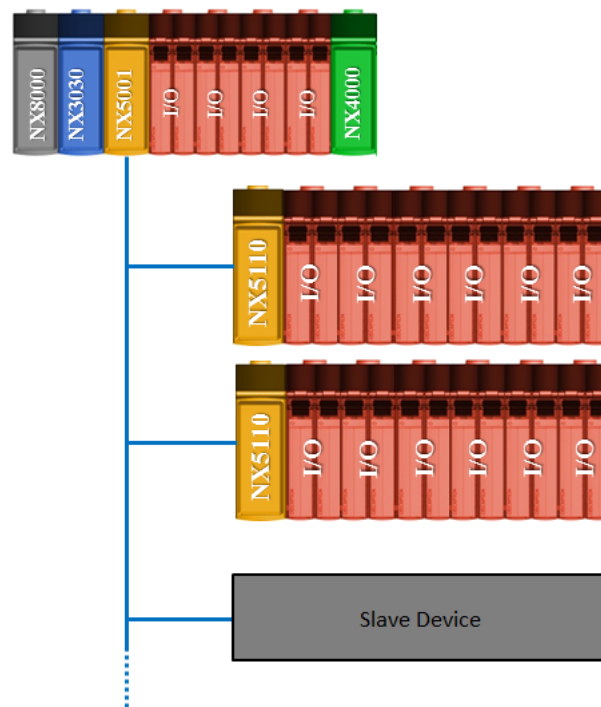

Figure 6: Simple PROFIBUS-DP Architecture

2.9.2. Architecture B: Redundant PROFIBUS-DP Network

The redundant PROFIBUS-DP network configuration allows maintaining the redundant system operating even occurring a failure in a redundant slave's head, interruption in data transmission or line failure in one of the Master Interfaces. This type of configuration consists of a CPU connected to two PROFIBUS-DP Master Interfaces (NX5001). These interfaces make up networks A and B, each with their heads NX5210. In the example below the bus consists of a CPU NX3030 and two Nexto PROFIBUS-DP NX5001 Masters.

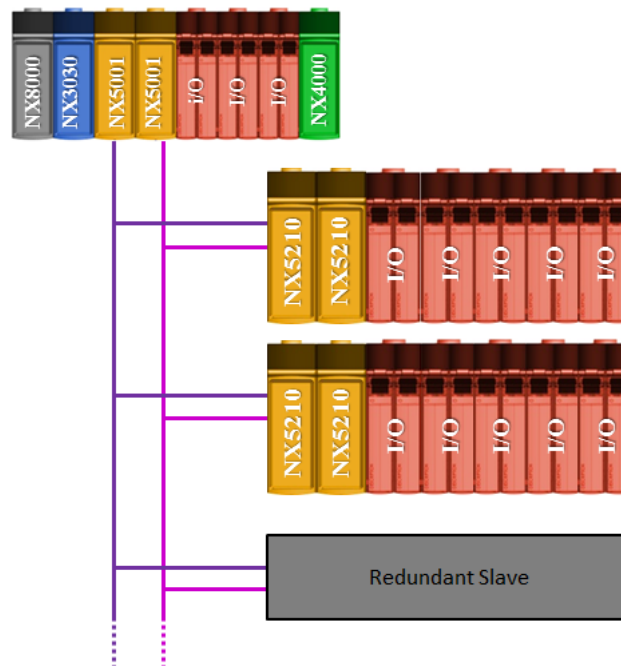

Figure 7: Redundant PROFIBUS-DP Architecture

2.9.3. Architecture C: Redundant PROFIBUS-DP Network with Master's Redundancy

This architecture keeps the operation of the system even in a failure of a redundant slave's head, a disruption of data transmission lines, in one of the Interfaces or in one of the masters. This type of configuration consists of two Master's PLCs, each connected to two Master PROFIBUS-DP Interfaces. In the example presented each CPU is composed of a NX3030 and two Nexto PROFIBUS-DP NX5001 Masters.

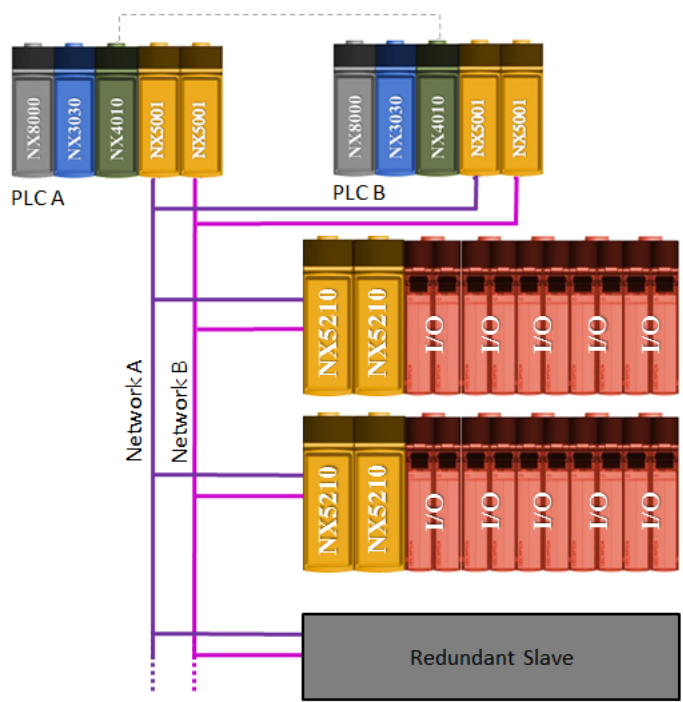

Figure 8: Redundant PROFIBUS-DP Architecture with Half-Cluster Redundancy

3. Installation

This chapter presents the steps to install the PROFIBUS fieldbus head NX5x10.

3.1. Electrical Installation

DANGER

When performing any installation of an electrical panel, make sure that its power source is **TURNED OFF**.

The backplane rack installation can be seen on the figure below.

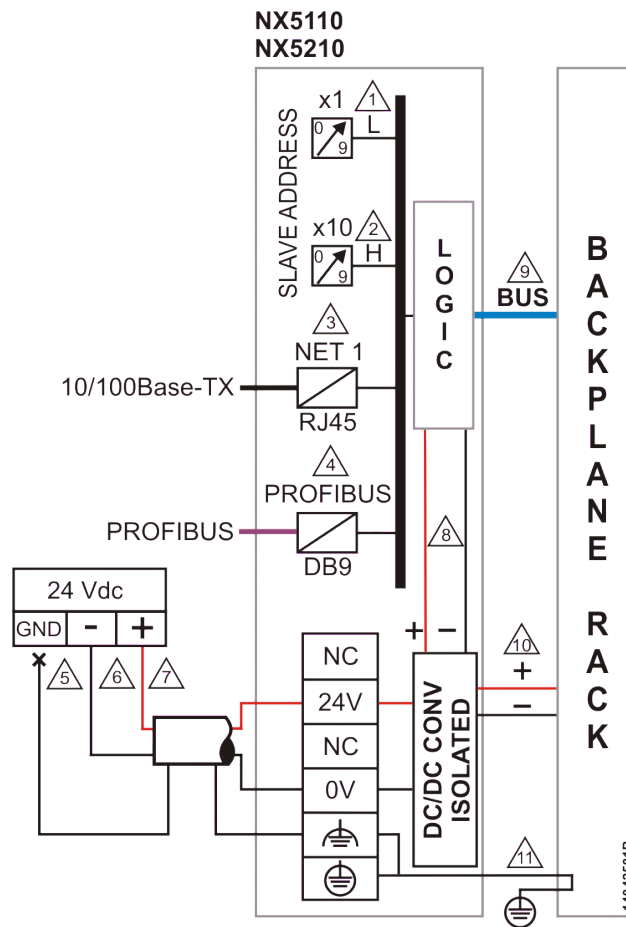

Figure 9: Electrical Diagram

Diagram Notes:

- 1, 2 - The address of the PROFIBUS-DP Slave is set by key x1 and x10 so that the unit is set in the key x1 and the ten is set in the key x10. As an example, the rack with address 15 must have 5 in x1 and 1 in x10.
- 3 - Standard Ethernet interface 10/100Base-TX to access the Diagnostics and Firmware update through Web page.
- 4 - Use the cable AL-2303 for PROFIBUS-DP fieldbus network and one of the following connectors:
 - AL-2601 is a connector for PROFIBUS-DP fieldbus network without internal termination. It can be used to connect any PROFIBUS-DP equipment in a position in which the termination is not required.
 - AL-2602 is a connector for PROFIBUS-DP fieldbus network with internal termination. It should be used on PROFIBUS-DP equipment located at the ends of the fieldbus network.

3. INSTALLATION

Altus also offers a second option for requirements where reliability and availability are key requirements. For these cases a connector AL-2605 should be used at each end of the field network and all modules PROFIBUS-DP without internal termination connectors should be used with AL-2601. More information about the AL-2605 module can be found in document CE104705.

The use of two network PROFIBUS-DP terminations is obligatory. Each termination should be positioned at each end of the fieldbus.

5 - The grounding from the external power source is connected to the terminal . Use cables from 0.5 to 1.0 mm².

6 - The power supply is connected to terminal 0 V. Use 0.5 mm² cables. For further information on the connector's usage, please refer to the Nexto Series User Manual- MU214600.

7 - The power supply is connected to terminal 24 V. Use 0.5 mm² cables. For further information on the connector's usage, please refer to the Nexto Series User Manual- MU214600.

8 - The power supply feeds the internal circuit directly.

9 - Local data bus.

10 - The module feeds the other modules of the Nexto Series through rack connection.

11 - The grounding of the module is done via the Nexto Series rack.

3.2. Mechanical and Electrical Assembly

The mechanical assembly of this module is described in Nexto Series User Manual - MU214600. The NX5110 module must be installed at the slot 0. The NX5210 module must be placed side by side at the slot 0 and 2. The modules must be added at the device tree below a PROFIBUS-DP Master.

ATTENTION

Products with broken warranty seal are not covered in warranty.

CAUTION



The device is sensitive to static electricity (ESD). Always touch in a metallic grounded object before handling it.

DANGER



Nexto Series can operate with voltage up to 250 Vac. Special care must be taken during the installation, which should only be done by qualified technical personnel. Do not touch on the wiring field when in operation.

3.3. Protection Circuit

For further information, consult the "*Lightning Protection*" section of the Nexto Series User Manual - MU214600.

ATTENTION

Atmospheric discharges (thunders) may cause damages to the product although its protections. Additional protections should be used if the product's power comes from a power supply located outside the panel where it is installed because it could be vulnerable to this kind of discharges. If the field wiring of the output points is susceptible to this kind of discharge, surge suppressors should be used.

3.4. PROFIBUS-DP Network Installation

The PROFIBUS-DP network installation is described at the PROFIBUS-DP Master NX5001 User Manual – MU214601.

4. CONFIGURATION

Module	Description	Consumption	Bytes Quantity of Input Data	Bytes Quantit	Parameter Bytes
NX1001	24 Vdc 16 DI Module	160 mA	2	-	8
NX1001 HSC	24 Vdc 16 DI Module	160 mA	16	11	8
NX1005	24 Vdc 8 DO Transistor / 8 DI	160 mA	1	1	7
NX1005 HSC	24 Vdc 8 DO Transistor / 8 DI	160 mA	15	12	7
NX1800	24 Vdc 8 DI Safety	200 mA	5	4	27
NX2001	24 Vdc 16 DO Transistor Module	140 mA	-	2	1
NX2020	16 DO Relay Module	140 mA	-	2	1
NX2800	24 Vdc 4 DO Transistor Safety	200 mA	4	5	20
NX6000	8 AI Voltage/Current Module	270 mA	16	-	11
NX6010	8 AI Thermocouple Module	270 mA	16	-	11
NX6020	8 AI RTD Module	300 mA	16	-	11
NX6100	4 AO Voltage/Current Module	130 mA	-	8	5
NX9999	Slot reservad	-	-	-	1
-	Hardware double width	-	-	-	1
NJ1001	24 Vdc 16 DI Module	160 mA	2	-	5
NJ2001	24 Vdc 16 DO Transistor Module	165 mA	-	2	1
NJ6000	8 AI Voltage/Current Module	270 mA	16	-	11
NJ6010	8 AI Thermocouple Module	270 mA	16	-	11
NJ6020	8 AI RTD Module	300 mA	16	-	11
NJ6100	4 AO Voltage/Current Module	130 mA	-	8	5

Table 7: I/O Modules Information

4.2.2. Simple Network

In order to configure a simple network using the Nexto Series, first it is necessary to define the main bus with CPU and PROFIBUS-DP master NX5001, followed by the PROFIBUS network remotes. Figure 4-2 shows the Add Device window, which is opened by right-clicking the NX5001 master. Here the NX5110 must be added.

4. CONFIGURATION

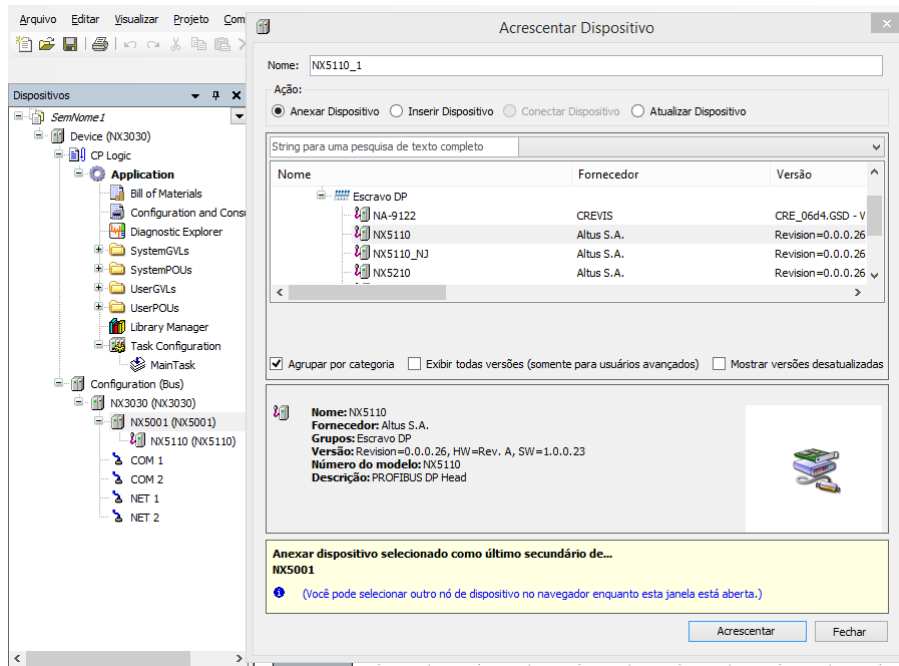

Figure 11: Adding a PROFIBUS-DP Head in a Simple Network

After inserting the NX5110 PROFIBUS head, it must be configured in its tab, as shown in the Figure below. These parameters are described in section [PROFIBUS-DP Head Parameters](#).

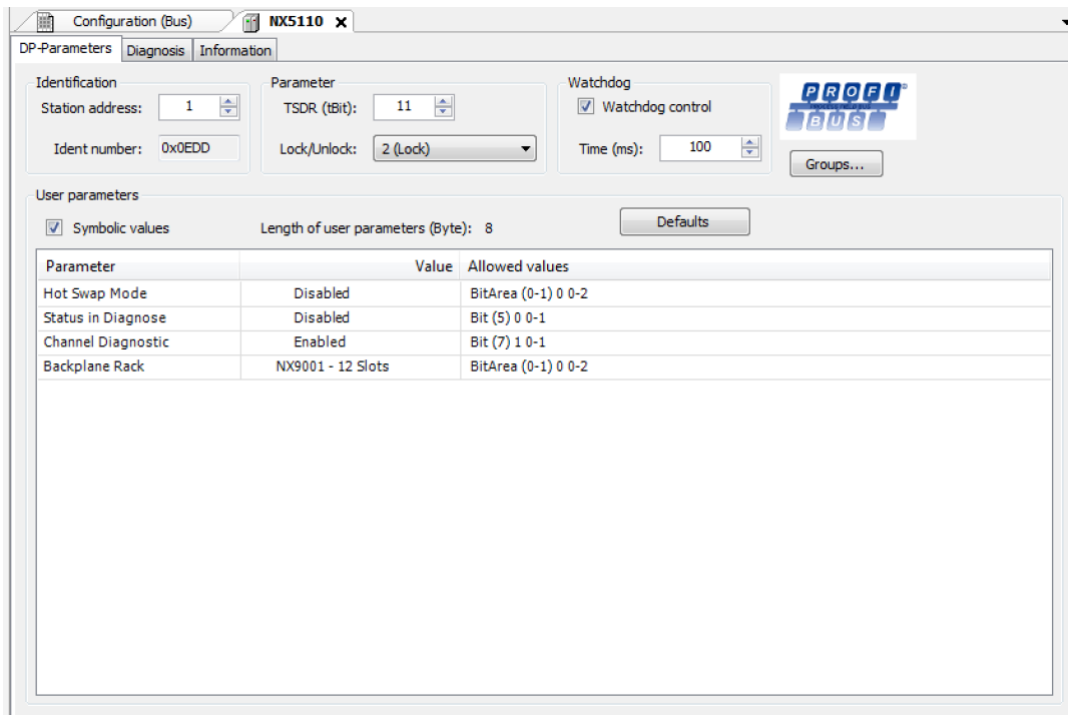

Figure 12: PROFIBUS-DP Head NX5110 Configuration

After configuring the PROFIBUS head, the I/O modules can be added. It is important to note that the order in the bus is given by the order of insertion, as shown in the Figure below.

4. CONFIGURATION

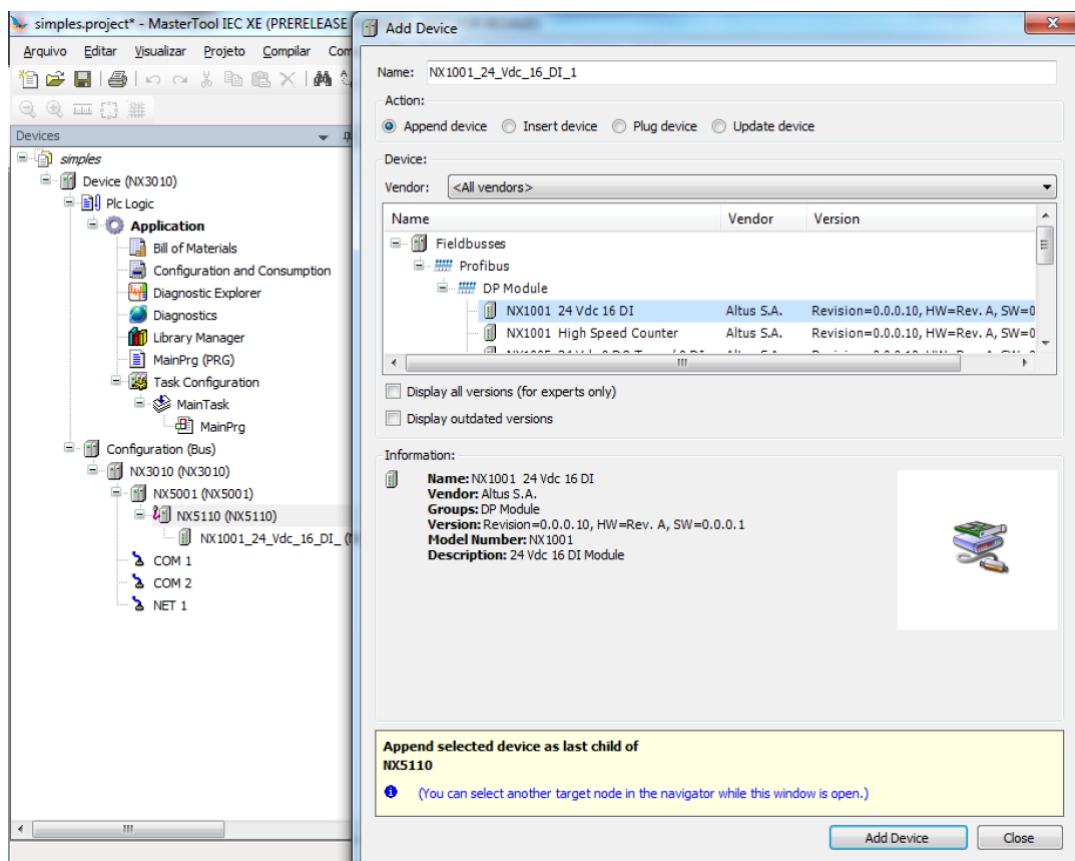

Figure 13: Adding I/O Modules to the Bus

I/O module configuration is made through the graphical interface, as shown in Figure below, which presents the configuration of an NX1001.

4. CONFIGURATION

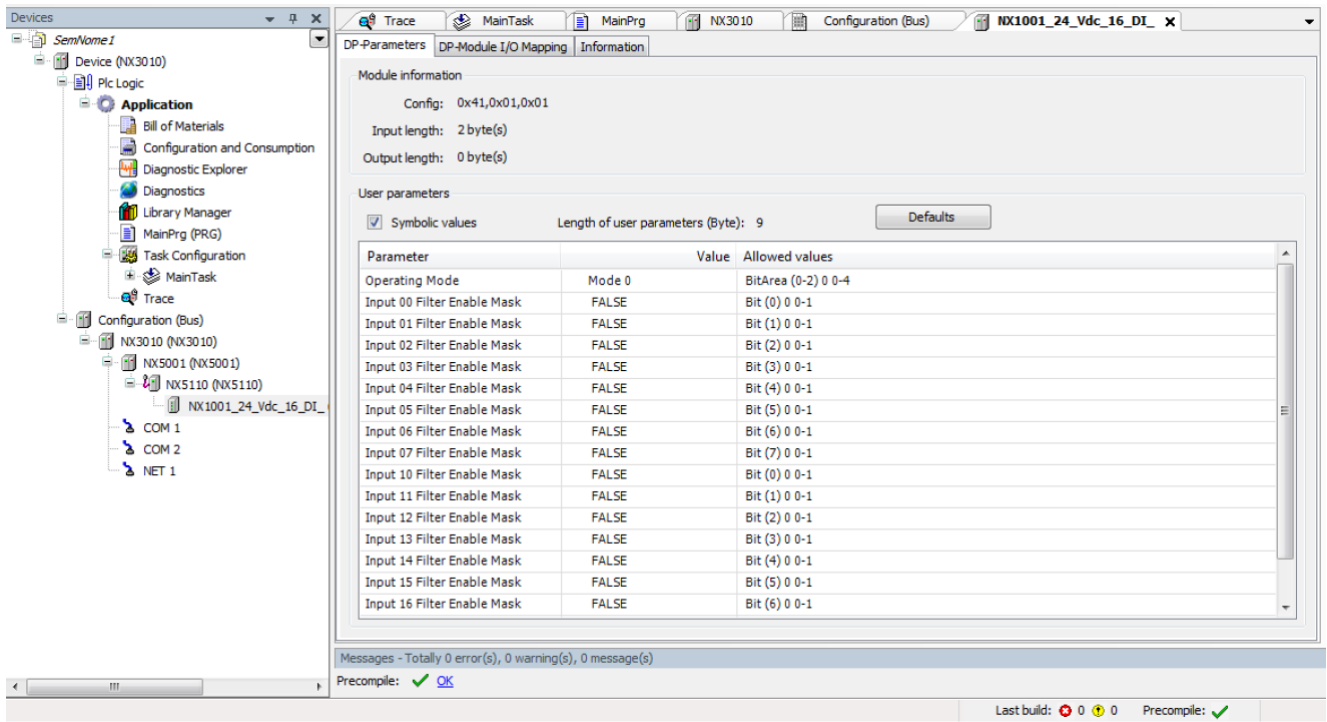

Figure 14: NX1001 Module Configuration Example

4.2.3. Redundant Network

The configuration of a redundant network is similar to the simple one, however in this case, it must be inserted an NX5210 instead of an NX5110, and after inserting all the I/O modules, the Redundant virtual module NX9900 must be inserted, which is used to provide information to the NX5001 PROFIBUS-DP Master. Figure 4-6 illustrates the insertion of the module.

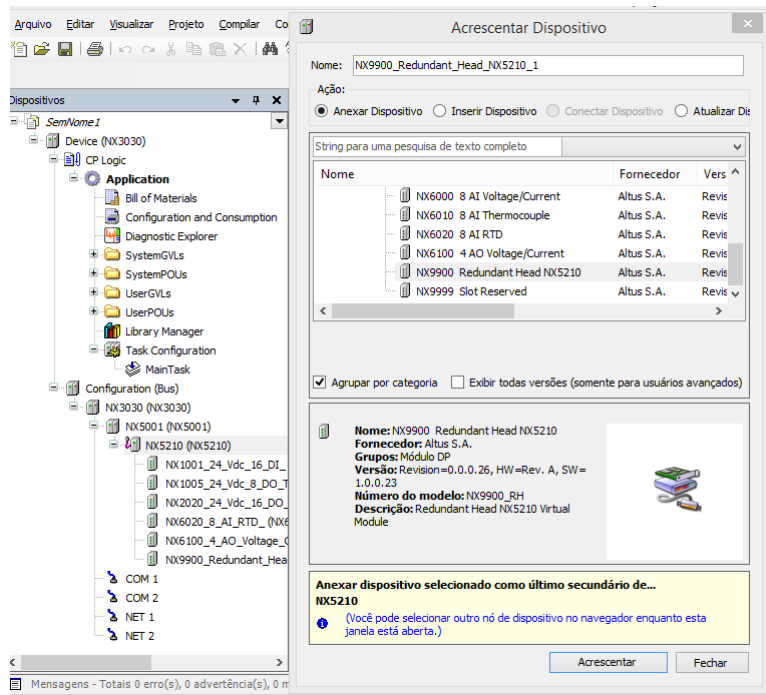

Figure 15: Insertion of Redundant Virtual Head NX9900

MasterTool’s tree view will end up as shown in the Figure below.

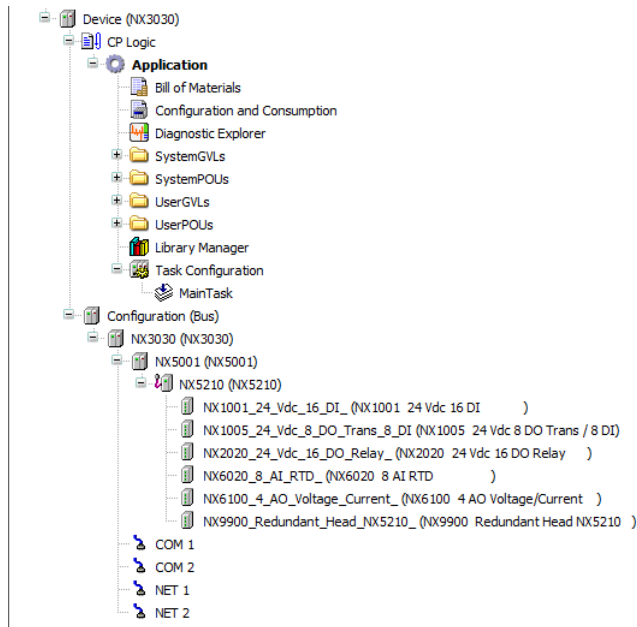

Figure 16: Tree view of a Slave with Redundant Network

ATTENTION

It’s not necessary to insert two PROFIBUS-DP NX5210 redundant heads in the project, even though a second one should be physically placed in the bus second position.

The PROFIBUS-DP redundant head’s parameterization can be seen in section [Modules Parameters](#).

4.3. Module Parametrization

Nexto Series’ modules may require that the user configure its parameters so it may work properly. Both the PROFIBUS heads and I/O modules have parameters that must be configured.

NX5110 and NX5210 parameters are basically identical, except for the Manual Switchover parameter. The parameters are set in the Master’s configurator.

ATTENTION

The parameterization is made in a friendly environment through menus. This is the case of most PROFIBUS Master Configuration softwares.

4.3.1. PROFIBUS-DP Head Parameters

NX5110 and NX5210 PROFIBUS heads have the following parameters:

- NX5110 and NX5210 PROFIBUS heads have the following parameters:
- Watchdog
- Hot Swap Mode
- Only Consists Declared Modules
- Status in Diagnose
- Channel Diagnostic
- Backplane Rack
- Manual Switchover

4.3.1.1. Station Address

This parameter defines the PROFIBUS head's address in the network. The value set in this field is compared to the one set in the Slave Address rotatory switches x1 and x10 found in the module's front. If the configured address differs from the one set in the switches, the device will indicate such issue in a diagnostic (see chapter [Diagnostics](#)). The range of valid values is from 1 to 99.

4.3.1.2. Watchdog

This parameter defines the head's behavior when it loses communication with the Master. It can have the following values:

- Disabled: After the loss of communication with the Master, the head keeps its operating state and the outputs remain in the last received value.
- Enabled: After the loss of communication with the Master, the head starts the defined watchdog timer. During this time, the outputs remain frozen in the last received value. If the communication is not reestablished by the end of this timer, the head enters Off-Line State and brings the outputs to safe state.

The configured watchdog time will depend on the application. If it is a redundant PLC system, this time should be larger than the PLC Switchover time.

4.3.1.3. Hot Swap Mode

It is considered "startup" the first time the PROFIBUS head enters in On-Line state after being powered. If there's a pair of NX5210 working as a redundant slave, it is considered "startup" when one of them enters in Primary On-Line.

The PROFIBUS head can start in three different configurations: hot swap disabled, hot swap enabled with startup consistency and hot swap enabled without startup consistency.

- Hot swap Disabled

All modules must be present in the bus all the time.

The PROFIBUS head goes to Error State when it detects that a module:

- Is absent
- Is defective
- Hot Swap Enabled, startup consistency

The head verifies if all declared modules are present in the bus during startup.

The PROFIBUS head goes to Error State when it detects during startup that a module:

- Is absent
- Is defective

After the startup, if a module falls into one of the previously mentioned situations, the system will carry on working and warn the problem through diagnostics.

When there's a power failure, even if it's temporary, and there's an absent module, the head will go to Error since it is considered a startup situation.

This option is the most recommended, since it ensures the system's integrity at startup, but afterwards it allows the hot swap of modules.

For a pair of NX5210 working as a redundant slave, the consistency test will only happen at startup, i.e. it won't happen again after a Switchover.

- Troca a quente habilitada sem consistência na partida. (Enabled, no startup consistency)
Permite que o sistema rode mesmo com módulos nas seguintes situações:

- Is absent
- Is placed in the wrong slot
- Is not configured for the slot it is in
- Is not declared in that bus
- s defective

All these situations are reported through diagnostics. This option is recommended during the system's development, since it enables module changes and power resets without all modules being in place.

4.3.1.4. Only Consists Declared Modules

This parameter allows the user to choose if the rules applied in the Hot Swap Mode parameter are valid only for declared modules. For now, this parameter only supports declared modules.

4.3.1.5. Status in Diagnose

The PROFIBUS head may present in its PROFIBUS diagnostics some information related to problems in modules and system status.

This parameter defines the behavior of diagnostics generation:

- Disabled: The diagnostics generation only happens when there's a variation in the data from modules
- Enabled: The diagnostics generation happens either when there's a variation in the data from modules or in the system status

The need for enabling or not the sending of status in diagnose exists because some Master devices consider the presence of diagnostics as an error.

By disabling this option, the Mater won't indicate when the head has an error. An example where it is recommended to disable this option is the Siemens PROFIBUS Master.

4.3.1.6. Channel Diagnostic

This parameter controls the sending of Channel diagnostics within a diagnostics frame of the Nexto PROFIBUS slave:

- Disabled: If there are Channel diagnostics in the modules, they will be suppressed, so only the device's and the module's diagnostics will be circulating the network
- Enabled: The Channel diagnostics will always be sent in the extended diagnostics frame

The format of the PROFIBUS diagnostics can be seen in Figure 6-1 and in section [PROFIBUS Diagnostics](#).

4.3.1.7. Backplane Rack

This parameter defines the size of the rack being used in the remote. There are five models available in the Nexto series:

- NX9000: 8-slot Backplane Rack
- NX9001: 12-slot Backplane Rack
- NX9002: 16-slot Backplane Rack
- NX9003: 24-slot Backplane Rack
- NX9010: 8-slot Backplane Rack (No Hot Swap, only available for NX5110)

4.3.1.8. Manual Switchover (only NX5210)

This parameter allows the redundant head to accept a Switchover request by the PROFIBUS Master and change its operating state:

Are two possible values:

- Disabled: The redundant head will refuse a Switchover request by the Master and keep its operating state
- Enabled: The redundant head will accept a Switchover request by the Master and change its operating state

4.3.2. Modules Parameters

The modules parameters are specified in their datasheet document.

If there's more than one module of a given type, it is necessary to configure them independently.

ATTENTION

The parameterization is made in a friendly environment through menus. This is the case of most PROFIBUS Master configuration softwares.

The quantity of parameters in each module varies. The module's datasheet may present some byte or bit values as constants – they should be precisely copied to ensure the correct parameterization.

Na Figura abaixo são apresentados os parâmetros do módulo NX6000 de uma configuração usada como exemplo. Na janela do software MasterTool IEC XE aparecem os parâmetros do módulo, sendo o primeiro parâmetro geral do módulo (filtro de supressão de ruído) e os subsequentes relacionados a cada canal, onde os parâmetros estão agrupados a cada 3 (tipo de canal, filtro digital e valor padrão de cabo rompido). Os demais parâmetros encontrados na CT do módulo NX6000 e que não estão disponíveis nesta tela possuem valores padrão, devido ao consumo de dados no frame de parametrização que é limitado pela norma PROFIBUS.

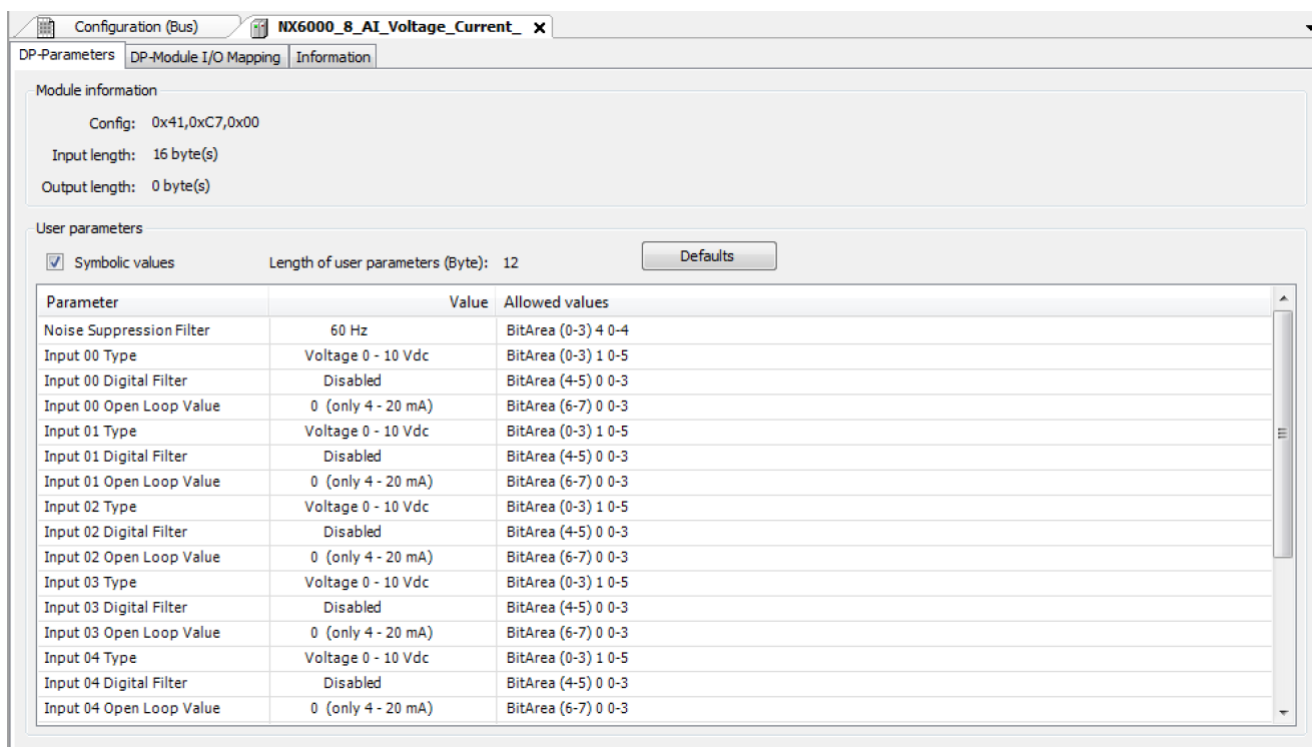

Figure 17: NX6000 Module Parameters

In the Figure below shows the editing of a Type parameter in channel 0.

4. CONFIGURATION

Parámetro	Valor	Valores Permitidos
Noise Suppression Filter	60 Hz	BitArea (0-3) 4 0-4
Input 00 Type	Voltage 0 - 10 Vdc	BitArea (0-3) 1 0-6
Input 00 Digital Filter	Not Configured	BitArea (4-5) 0 0-3
Input 00 Open Loop Value	Voltage 0 - 10 Vdc	BitArea (6-7) 1 0-2
Input 01 Type	Voltage -5 to +5 Vdc	BitArea (0-3) 1 0-6
Input 01 Digital Filter	Voltage -10 to +10 Vdc	BitArea (4-5) 0 0-3
Input 01 Open Loop Value	Current 0 - 20 mA	BitArea (6-7) 1 0-2
Input 02 Type	Current 4 - 20 mA	BitArea (0-3) 1 0-6
Input 02 Digital Filter	Current -20 to +20 mA	BitArea (4-5) 0 0-3
Input 02 Open Loop Value	Voltage 0 - 10 Vdc	BitArea (6-7) 1 0-2
Input 03 Type	Disabled	BitArea (0-3) 1 0-6
Input 03 Digital Filter	Min Value (only 4 - 20 mA)	BitArea (4-5) 0 0-3
Input 03 Open Loop Value	Voltage 0 - 10 Vdc	BitArea (6-7) 1 0-2
Input 04 Type	Disabled	BitArea (0-3) 1 0-6
Input 04 Digital Filter	Min Value (only 4 - 20 mA)	BitArea (4-5) 0 0-3
Input 04 Open Loop Value	Voltage 0 - 10 Vdc	BitArea (6-7) 1 0-2
Input 05 Type	Disabled	BitArea (0-3) 1 0-6
Input 05 Digital Filter	Min Value (only 4 - 20 mA)	BitArea (4-5) 0 0-3

Figure 18: NX6000 Module Parameter Selection

ATTENTION

The concepts of the NX6000 parameters are not the object of this manual. If necessary, consult the module's datasheet.

ATTENTION

The usage of MasterTool IEC XE programmer is not the object of this manual. If necessary, consult MasterTool IEC XE User Manual (MU299609).

4.4. PROFIBUS-DP Head's Informative and Configuration Menu

The access to the Nexto PROFIBUS-DP Head's Informative and Configuration Menu, just as the access do detailed diagnostics, are available in levels. To access the menu's information, browse the levels and change configurations, a long press in the OTD switch is required. To browse items in the same level, a short press in the OTD switch is required. Consult the section One Touch Diag to learn the operation and differences between pressings in the diagnostic switch.

Table below shows the menu levels available in the PROFIBUS-DP Heads. It also shows the type of the field – whether it is informative or configurable.

Level 1	Level 2	Level 3	Type
HARDWARE	TEMPERATURE	-	Informative
	CONTRAST	CONTRAST LEVEL	Configurable
	BACK	-	Level Return
LANGUAGE	ENGLISH	>ENGLISH	Configurable
	PORTUGUESE	>PORTUGUESE	Configurable
	SPANISH	>SPANISH	Configurable
	BACK	-	Level Return
NETWORK	ADDR.. IP NET 1		Informative
	MASC. NET 1	-	Informative
	BACK		Level Return
SOFTWARE	FIRMWARE		Informative
	BOOTLOADER	-	Informative
	BACK		RLevel Return
BACK	-	-	Level Return

Table 8: PROFIBUS-DP Head Menu Levels

As already shown in Table above, among the options are helpful information to the user, such as:

- Information on hardware resources:

TEMPERATURE – Internal Temperature of the PROFIBUS Head (e.g. 36 C 97 F)
CONTRAST – PROFIBUS Head's LCD contrast adjustment

- Change in PROFIBUS-DP Head menu language:

PORTUGUESE – Changes language to Portuguese
ENGLISH – Changes language to English
SPANISH – Changes language to Spanish

- Information on the device's configured network:

ADDR. IP NET 1 – IP Address (e.g. 192.168.0.1)
MASC. NET 1 – Subnet Mask (e.g. 255.255.255.0)

- Information on software versions:

FIRMWARE – Software version of the PROFIBUS-DP Head (e.g. 1.0.0.0)
BOOTLOADER – Bootloader version of the PROFIBUS-DP Head (e.g. 1.0.0.0)

Figure below brings an example of how to operate the menu of the Nexto PROFIBUS-DP Heads through the adjustment of the contrast from the Status screen. Not only does it facilitate configuration, it's also easy to identify all other levels and the type of pressing to navigate it. A short press increments contrast (brighter), being that the next pressing after the full value sets it to its lowest (darker). A long press confirms the setting of the contrast and returns to the previous level.

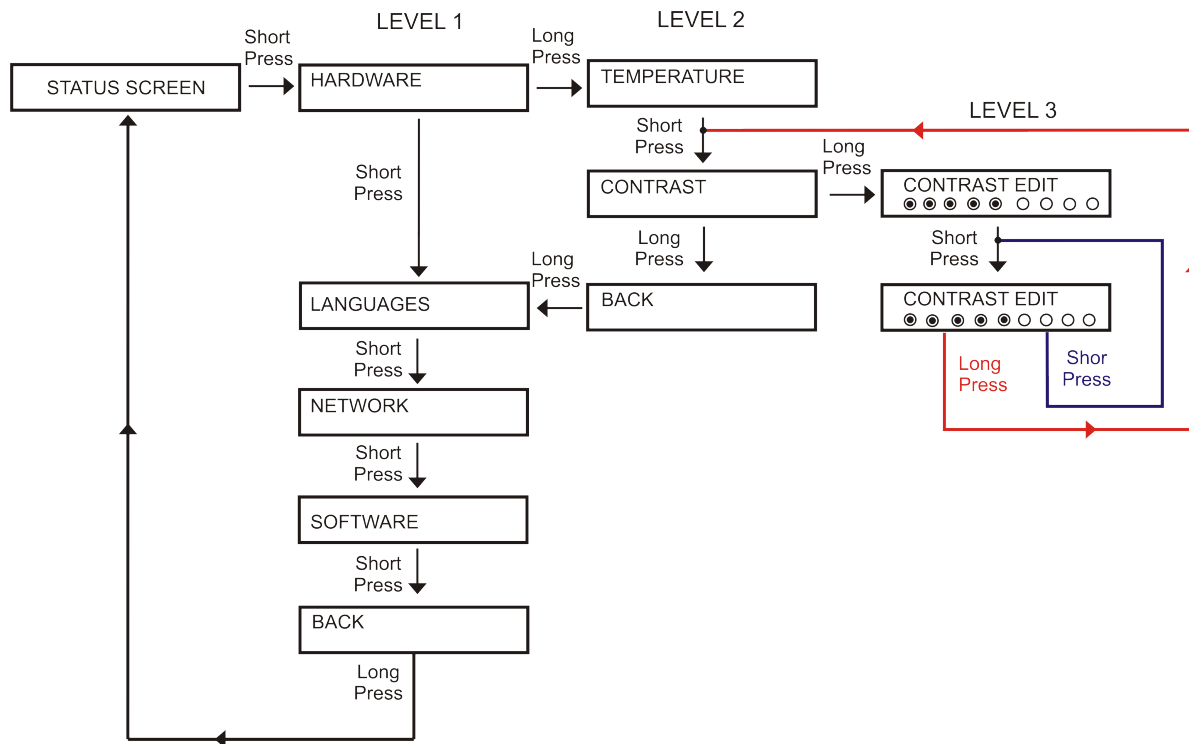

Figure 19: Contrast Adjustment

There are other ways to exit the menu than a long press in the first level's BACK:

- A short press, at any moment, in another module of the bus will make the Head exit its menu and show the pressed module's diagnostics
- More than 5 seconds of inactivity at any level

5. Operation

5.1. Sync/Freeze Mode

Sync/Freeze operation is described at PROFIBUS-DP Master User Manual – MU214601.

5.2. NX5210 Redundancy

This section covers the redundancy mechanism of the NX5210 head.

5.2.1. General Features

A redundant PROFIBUS-DP slave is composed of two NX5210 redundant heads mounted side by side and sharing the same I/O modules. The redundancy uses a proprietary algorithm which makes it compatible only with Masters from Altus product series (AL Series, Ponto Series or Nexto Series).

There's no order or precedence that determines which head will be Active or Standby, such state allocation is random. However, the head's software ensures that two heads in the same bus won't be Active at the same time.

They operate independently. The Active head commands the input and output devices while the Standby head is waiting for a command to make it Active.

The redundancy of the NX5210 heads is possible thanks to the Switchover command. It executes the state change between the heads of the redundant slave when there's a failure in the Active head. This state change between the heads is made autonomously, so it doesn't require any manual operation, however it is still possible to enable the manual execution of Switchovers.

To use the NX5210 redundant heads, it is necessary to declare the redundant virtual module NX9900 at the last position of the bus. This is not an actual physical module, but merely a logical device declared at the Master's configurator. If the master is Nexto's NX5001, then MasterTool IEC XE will be used, other Altus Masters will require the ProfiTool software.

Both NX5210 redundant heads in the same bus must have the same address.

5.2.2. Switchover

In a redundant system, the state change between Active and Standby is named Switchover.

The Switchover may happen automatically if the redundant device detects a failure in the active head's network or any other internal failure. In this case, the device performs the Switchover to the working network and the NX5001 displays in its diagnostics which network is currently Active. The redundant heads have the autonomy to make a Switchover in case of failure, and the application can execute such command as well.

As said, the Switchover may be commanded by the PLC. In this case, it might be necessary that all devices of a given network (A or B) be Active, so that any sort of operation or maintenance is performed in the Standby network.

Table below lists the events that trigger a Switchover, the action sequence and the state of the heads afterwards.

Event	Action	Next State of the Active Head	Next State of the Standby Head
Disconnection between active head and Master interface	Switchover command by the Standby head	Offline	Online
Standby head receives the Switchover command	Switchover command by the Standby head	Standby	Online
Active Head receives the Switchover command	Switchover command by the Active head	Standby	Online
Active head detects a failure that might harm the system's operation	Switchover command by the Active head	Error	Online
Active head loses power due to a failure in its internal or external power source unit	Standby head detects bus inactivity and executes the Switchover	Shut Down	Online

Event	Action	Next State of the Active Head	Next State of the Standby Head
Active head is removed for a hot-swap	Standby head detects bus inactivity and executes the Switchover	Absent	Online
Active head enters Watchdog	Standby head detects bus inactivity and executes the Switchover	Watchdog	Online

Table 9: Switchover Events

5.2.2.1. Módulo virtual NX9900

The NX9900 virtual redundant module’s purpose is to inform the Master about the state of the redundant head and transmit Switchover commands.

This module must always be placed in the last position when configuring the bus at the Master’s configuration software. Since it’s a virtual module, it doesn’t occupy a physical slot in Nexto’s bus.

This module has 2 input bytes and 2 output bytes. The input bytes carry information on the state of the head, while the output bytes have the Switchover commands. PLC commanded Switchovers must be first enabled in the head’s parameters – consult section [Manual Switchover \(only NX5210\)](#).

PLC commanded Switchovers are made by forcing the corresponding variable, as shown in Figure below.

By writing TRUE in one of the first two bits, a Switchover is forced to the chosen network (where Network A is the one connected to the left head). The bits named “Reserved” are not used. If both bits are TRUE at the same time, bit 0 (Network A) will prevail.

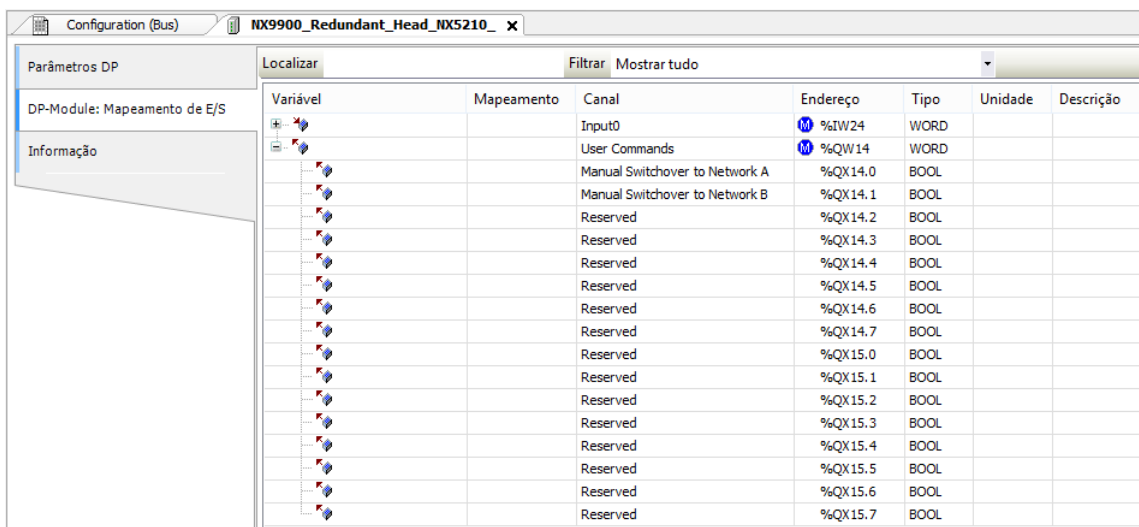

Figure 20: Manual Switchover Command

ATTENTION

To ensure the necessary time for the Switchover, the redundancy diagnostics must be consulted before sending a new command to make sure that the previous Switchover has been performed.

6. Diagnostics

6.1. PROFIBUS Diagnostics

This chapter presents the PROFIBUS diagnostics format, according to norm EN 50170.

If the PROFIBUS Master programmer is MasterTool IEC XE, section [Nexto PROFIBUS Diagnostics](#).

The reading of this section is only recommended in the following situations:

- Users whose PROFIBUS Master's programmer is not capable of interpreting diagnostics messages through the GSD
- The application program uses the diagnostics (in case the CPU has access to these bits)

If the PROFIBUS Master programmer can interpret diagnostics messages, the reading of this section is not necessary.

The diagnostics frame's general format must have no more than 240 bytes, distributed as follows:

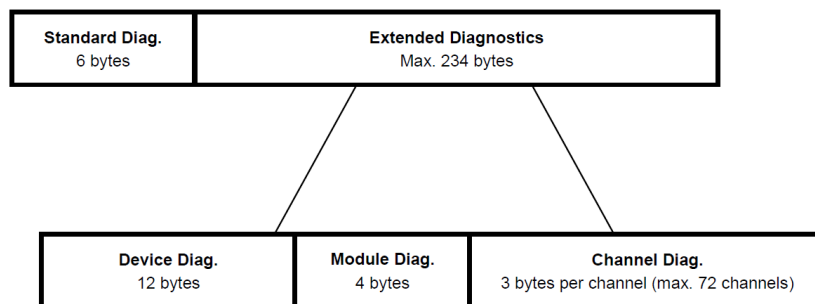

Figure 21: PROFIBUS Diagnostics Frame Format

The next sections will explore each of the previous figure's blocks in detail.

6.1.1. Standard Diagnostics

The standard diagnostics defined by the norm is made of 6 bytes.

The table below shows the description of each bit:

Byte								Description
7	6	5	4	3	2	1	0	
Byte 0 - Status 1								
							1	Station_non_Existent: slave not found in the network.
							1	Station_Not_Ready: slave not ready for communication.
					1			Cfg_Fault: indicates that the slave configuration is different than the Master's.
			1					Ext_diag: indicates that the slave has an extended diagnostics message to be read by the Master.
			1					Not_Supported: indicates that the slave has received an unsupported command.
		1						Invalid_Slave_Response: indicates that the slave's response to the master was not recognized.
	1							Prm_fault: indicates that there has been an error in the sending of parameters to the slave.
1								Master_Lock: indicates that the module has been parameterized by another master.
Byte 1 - Status 2								
1								Deactivated: the slave was declared inactive in the parameterization.
	X							Reserved.
		1						Sync_Mode: Set by the slave when receiving the Sync command.

Byte								Description
7	6	5	4	3	2	1	0	
			1					Freeze_mode: Set by the slave when receiving the Freeze command.
				1				WD_On: Set by the slave when its Watchdog is activated.
					1			Always TRUE by the slave.
						1		Stat_Diag: Set by the slave to warn that the diagnostics must be read by the master.
							1	Prm_Req: Set by the slave to warn that it must be parameterized and configured.
Byte 2 - Status 3								
1								Ext_Diag_Overflow: Set if the extended diagnostics information is beyond the slave's capacity as defined in the Ext_Diag_Data of the GSD file.
	X	X	X	X	X	X	X	Reserved.
Byte 3 - Status 4 - Master_Add								Address of the master that parameterized the slave. If no master has parameterized it, the value is 255.
Byte 4 e 5 - Status 5/6 - Ident_Number								Slave device identifier (device number, as registered at the PROFIBUS committee).

Table 10: PROFIBUS Diagnostics Frame Fields

6.1.2. Extended Diagnostics

The following bytes describe the situation in the slave in detail. This detail varies by slave device and/or manufacturer. If the slave sends the extended diagnosis, the bit *Ext_Diag* is turned on. Extended diagnoses can be subdivided into three parts:

- [Device Diagnostics](#)
- [Module Diagnostics](#)
- [Channel Diagnostics](#)

6.1.2.1. Device Diagnostics

The following table presents the device's diagnostics format.

Size: block's size in bytes, including the overhead.

For the PROFIBUS heads NX5110 and NX5210, 12 bytes are allocated for diagnostics, thus distributed:

Byte								Description
7	6	5	4	3	2	1	0	
Byte 0 - Overhead								Number of bytes in the head's diagnostics.
0	0	0	0	1	1	0	0	Fixed in 12.
Byte 1 - Reserved								Reserved.
Byte 2 - Reserved								Reserved.
Byte 3 - Summarized								Head's summarized diagnostics.
							1	There's a bus configuration problem.
							1	One or more declared modules are absent.
					1			Two modules are swapped in the bus.
			1					One or more modules present in the bus are not declared.
			1					One or more modules in the bus have active diagnostics.
		1						One or more modules in the bus are in a non-functional state.
	1							One or more modules in the bus have parameterization error.
1								Indicates that it has exceeded the maximum number of input or output bytes.
Byte 4 - Summarized								Head's summarized diagnostics.

Byte								Description
7	6	5	4	3	2	1	0	
							1	Indicates that it has exceeded the maximum number of modules.
						1		There are configuration errors in NET1 interface.
					1			Indication that there is a failure in the local bus.
				1				Indicates that there's a hardware failure in the device.
			1					Indicates that there is a failure in the LCD.
		1						The switch is stuck for more than 20 seconds at least once while the CPU was powered. This diagnostics is only reset at the system's restart.
	1							Indicates that the PROFIBUS slave address has been altered.
1								Indicates failure in the internal thermometer.
Byte 5 - Summarized								Head's summarized diagnostics.
							1	High temperature alarm.
						1		Low temperature alarm.
					1			Indicates that the device has been restarted due to a power failure.
				1				Indicates that the device has been restarted due to a watchdog.
X	X	X	X					Reserved.
Byte 6 - Summarized								Head's summarized diagnostics.
X	X	X	X	X	X	X	X	Reserved.
Bytes 7 .. 10 – Absent Modules								Indicate absent modules in the respective bus positions.
Byte 11 – Network Address								PROFIBUS head's address, defined by keys x1 and x10.

Table 11: Device's Diagnostics Table

6.1.2.2. Module Diagnostics

The table below presents the module's diagnostics format, indicating its situation.

Byte								Description
7	6	5	4	3	2	1	0	
Byte 12 - Overhead								
0	1	Size						Size of the device's diagnostics.
Byte 13 – Module with Diag.								
Mód.7	Mod.6	Mod.5	Mod.4	Mod.3	Mod.2			Modules 2 to 7 with diagnostics.
Byte 14 - Module with Diag.								
Mód.15	Mod.14	Mod.13	Mod.12	Mod.11	Mod.10	Mod.9	Mod.8	Modules 8 to 15 with diagnostics.
Byte 15 - Module with Diag.								
Mód.23	Mod.22	Mod.21	Mod.20	Mod.19	Mod.18	Mod.17	Mod.16	Modules 16 to 23 with diagnostics.

Table 12: Module's Situation Bytes

ATTENTION

NX5210 PROFIBUS Redundant Head uses positions 0, 1, 2 and 3 of the bus, while NX5110 PROFIBUS Head uses positions 0 and 1. I/O modules that use two bus slots are identified by the smaller slot number.

6.1.2.3. Channel Diagnostics

Each channel has its identification and error cause, where each active diagnostics will use 3 bytes, even when each channel has two or more active diagnostics. Table 6-4 presents the format of the channel diagnostics.

Byte								Description
Byte 0 - Identifier								
7	6	5	4	3	2	1	0	
1	0	Ident						Bus position of the module with diagnostics
Byte 1 - Channel								
7	6	5	4	3	2	1	0	
0	0	Channel						Channel number
Byte 2 - Type of Diagnostics								
7	6	5	4	3	2	1	0	
0	0	0	Type of Diagnostics					Described at the module's datasheet document.

Table 13: Channel Diagnostics Format

For further details on the device's diagnostics, consult Norm EN 50170.

6.2. Nexto PROFIBUS Diagnostics

The NX5001 PROFIBUS Master receives the diagnostics data in the PROFIBUS format and decodes them in a structured variable form, making the access and understanding of them easier, and enabling their usage by the user application.

The table below presents the diagnostics structure of the Nexto PROFIBUS Head. This structure is only available when using Nexto PROFIBUS Master NX5001.

Direct Representation		Diagnostics Message	Symbolic Variable	Description
Variable				
Variável	Tamanho		DG_NX5110.*	
%QB(n)	BYTE	-	byStationAddress	Address.
%QB(n+1)	0	-	tPbusHeadA.tStatus1.bStation_Non_Existent	Nonexistent or non-responsive slave.
	1	-	tPbusHeadA.tStatus1.bStation_Not_Ready	The slave is not ready for data exchange cycle.
	2	-	tPbusHeadA.tStatus1.bCfg_Fault	Configuration error. The configuration is different than the one sent by the master.
	3	-	tPbusHeadA.tStatus1.bExt_Diag	Indicates that the extended diagnostics area is used.
	4	-	tPbusHeadA.tStatus1.bNot_Supported	Command not supported.
	5	-	tPbusHeadA.tStatus1.bInvalid_Slave_Response	Invalid slave response.
	6	-	tPbusHeadA.tStatus1.bPrm_Fault	Last parameter received is incorrect.
	7	-	tPbusHeadA.tStatus1.bMaster_Lock	Slave parameterized by another master.
	0	-	tPbusHeadA.tStatus2.bPrm_Req	Slave requires new parameterization and configuration.
	1	-	tPbusHeadA.tStatus2.bStat_Diag	Master needs to reach information from the slave.
	2	-	tPbusHeadA.tStatus2.bFixed_1	Value fixed in 1.

Direct Representation		Diagnostics Message	Symbolic Variable DG_NX5110.*	Description
Variable	Tamanho			
%QB(n+2)	3	-	tPbusHeadA.tStatus2.bWD_On	Indication that the watchdog supervisory mechanism is active.
	4	-	tPbusHeadA.tStatus2.bFreeze_Mode	Indicates that the slave received a Freeze command.
	5	-	tPbusHeadA.tStatus2.bSync_Mode	Indicates that the slave received a Sync command.
	6	-	tPbusHeadA.tStatus2.bReserved_06	Reserved.
	7	-	tPbusHeadA.tStatus2.bDeactivated	Slave was not designed.
%QB(n+3)	0	-	tPbusHeadA.tStatus3.bReserved_00	Reserved.
	1	-	tPbusHeadA.tStatus3.bReserved_01	Reserved.
	2	-	tPbusHeadA.tStatus3.bReserved_02	Reserved.
	3	-	tPbusHeadA.tStatus3.bReserved_03	Reserved.
	4	-	tPbusHeadA.tStatus3.bReserved_04	Reserved.
	5	-	tPbusHeadA.tStatus3.bReserved_05	Reserved.
	6	-	tPbusHeadA.tStatus3.bReserved_06	Reserved.
	7	-	tPbusHeadA.tStatus3.bExt_Diag_Overflow	Indicates that the quantity of active diagnostics exceeds the data capacity that the slave can send (defined by Ext_Diag_Data parameter of GSD).
%QB(n+4)	BYTE	-	tPbusHeadA.byMasterAddress	Indicates PROFIBUS-DP master address.
%QB(n+5)	WORD	-	tPbusHeadA.wIdentNumber	Identification number.
%QB(n+7)	BYTE	-	tPbusHeadA.byReserved_06	Reserved.
%QB(n+8)	BYTE	-	tPbusHeadA.byReserved_07	Reserved.
%QB(n+9)	0	CONFIG. MISMATCH	tSummarized.bConfigMismatch ⁽¹⁾	There is a configuration problem in the bus, such as a module in the wrong slot.
	1	ABSENT MODULES	tPbusHeadA.tSummarized.AbsentModules ⁽¹⁾	One or more declared modules are absent.
	2	SWAPPED MODULES	tPbusHeadA.tSummarized.bSwappedModules ⁽¹⁾	Two modules are swapped in the bus.
	3	NON-DECLARED MODULES	tPbusHeadA.tSummarized.bNonDeclaredModules ⁽¹⁾	One or more modules present in the bus are not declared.
	4	MODULES W/ DIAGNOSTIC	tPbusHeadA.tSummarized.bModulesWithDiagnostic ⁽¹⁾	One or more modules in the bus have active diagnostics.
	5	MODULES W/ FATAL ERROR	tPbusHeadA.tSummarized.bModuleFatalError ⁽¹⁾	One or more modules present in the bus are not functional.
	6	MODULES W/ PARAM. ERROR	tPbusHeadA.tSummarized.bModuleParameterError ⁽¹⁾	One or more modules present in the bus are with parameterization error.
	7	EXCEEDED NUM BYTES	tPbusHeadA.tSummarized.bExceededNumInOutBytes	Indicates that the maximum number of I/O bytes has been exceeded.
	8	EXCEEDED MAX NUM MODULES	tPbusHeadA.tSummarized.bExceededMaxModules	Indicates that the maximum number of modules has been exceeded.
	9	-	bReserved_9	Reserved.
	10	BUS ERROR	tPbusHeadA.tSummarized.bLocalBusError	Indicates that there is a failure in the local bus.

Direct Representation		Diagnostics Message	Symbolic Variable DG_NX5110.*	Description
Variable	Tamanho			
Variável				
	11	HARDWARE FAILURE	tPbusHeadA.tSummarized. bHardwareFailure	Indicates that there is a hardware failure in the device.
	12	-	bReserved_12	Reserved.
	13	OTD SWITCH ERROR	tPbusHeadA.tSummarized. bOTDSwitchError	The OTD switch was stuck for more than 20 seconds at least once while the slave was powered. This diagnostics is only cleared when the system is restarted.
	14	ADDRESS MODIFIED	tPbusHeadA.tSummarized. bPbAddrSwitchChanged	Indicates that the slave's PROFIBUS-DP address has been altered.
	15	-	tPbusHeadA.tSummarized. bThermometerFailure	Indicates failure in the internal thermometer.
	16	-	tPbusHeadA.tSummarized. bOverTemperatureAlarm	Indicates the high temperature alarm.
	17	-	tPbusHeadA.tSummarized. bUnderTemperatureAlarm	Indicates the low temperature alarm.
	18	-	tPbusHeadA.tSummarized. bBrownOutReset	Indicates that the device has been restarted due to a power failure.
	19	-	tPbusHeadA.tSummarized. bWatchdogReset	Indicates that the device has been restarted due to a watchdog.
	20	HOT SWAP MODE ERROR	tPbusHeadA.tSummarized. bHotSwapModeError ⁽¹⁾	Informs that there has been an unusual situation in the bus and that the hot swap logic (parameterized by the user) has acted, taking the slave to an Error state.
	21	WRONG SLOT	tPbusHeadA.tSummarized. bWrongSlot	Indicates that the PROFIBUS-DP Head is powered and placed in the wrong bus slot.
	22..31	-	tPbusHeadA.tSummarized. bReserved_nn	Reserved.
%QB(n+13)	DWORD	-	tPbusHeadA.dwModuleNotPresent ⁽¹⁾	Indicates module presence in the respective bus positions.
%QB(n+17)	0	-	tPbusHeadB.tStatus1. bStation_Non_Existent	Nonexistent or non-responsive slave.
	1	-	tPbusHeadB.tStatus1. bStation_Not_Ready	Slave not ready for data exchange cycle.
	2	-	tPbusHeadB.tStatus1. bCfg_Fault	Configuration error, configuration different than sent by master.
	3	-	tPbusHeadB.tStatus1. bExt_Diag	Indicates usage of extended diagnostics.
	4	-	tPbusHeadB.tStatus1. bNot_Supported	Command not supported.
	5	-	tPbusHeadB.tStatus1. bInvalid_Slave_Response	Invalid slave response.
	6	-	tPbusHeadB.tStatus1. bPrm_Fault	Last received parameter is incorrect.
	7	-	tPbusHeadB.tStatus1. bMaster_Lock	Slave parameterized by another master.
	0	-	tPbusHeadB.tStatus2. bPrm_Req	Slave requires new parameterization and configuration.
	1	-	tPbusHeadB.tStatus2. bStat_Diag	Master needs to reach information from the slave.
	2	-	tPbusHeadB.tStatus2. bFixed_1	Value fixed in 1.
	3	-	tPbusHeadB.tStatus2. bWD_On	Indication that the watchdog supervisory mechanism is active.

Direct Representation		Diagnostics Message	Symbolic Variable DG_NX5110.*	Description
Variable	Tamanho			
%QB(n+18)	4	-	tPbusHeadB.tStatus2. bFreeze_Mode	Indicates that the slave received a Freeze command.
	5	-	tPbusHeadB.tStatus2. bSync_Mode	Indicates that the slave received a Sync command.
	6	-	tPbusHeadB.tStatus2. bRe- served_06	Reserved.
	7	-	tPbusHeadB.tStatus2. bDeactivated	Slave was not designed.
%QB(n+19)	0	-	tPbusHeadB.tStatus3. bRe- served_00	Reserved.
	1	-	tPbusHeadB.tStatus3. bRe- served_01	Reserved.
	2	-	tPbusHeadB.tStatus3. bRe- served_02	Reserved.
	3	-	tPbusHeadB.tStatus3. bRe- served_03	Reserved.
	4	-	tPbusHeadB.tStatus3. bRe- served_04	Reserved.
	5	-	tPbusHeadB.tStatus3. bRe- served_05	Reserved.
	6	-	tPbusHeadB.tStatus3. bRe- served_06	Reserved.
	7	-	tPbusHeadB.tStatus3. bExt_Diag_Overflow	Indicates that the quantity of active diagnostics exceeds the data capacity that the slave can send (defined by Ext_Diag_Data parameter of GSD).
%QB(n+20)	BYTE	-	tPbusHeadB.byMasterAddress	Indicates PROFIBUS-DP master address.
%QB(n+21)	WORD	-	tPbusHeadB.wIdentNumber	Identification number.
%QB(n+23)	BYTE	-	tPbusHeadB.byReserved_06	Reserved.
%QB(n+24)	BYTE	-	tPbusHeadB.byReserved_07	Reserved.
	0	CONFIG. MISMATCH	tSummarized.bConfigMismatch ⁽¹⁾	There is a configuration problem in the bus, such as a module in the wrong slot.
	1	ABSENT MODULES	tPbusHeadB.tSummarized. AbsentModules ⁽¹⁾	One or more declared modules are absent.
	2	SWAPPED MODULES	tPbusHeadB.tSummarized. bSwappedModules ⁽¹⁾	Two modules are swapped in the bus.
	3	NON- DECLARED MODULES	tPbusHeadB.tSummarized. bNon- DeclaredModules ⁽¹⁾	One or more modules present in the bus are not declared.
	4	MODULES W/ DIAGNOSTIC	tPbusHeadB.tSummarized. bModulesWithDiagnostic ⁽¹⁾	One or more modules in the bus have active diagnostics.
	5	MODULES W/ FATAL ERROR	tPbusHeadB.tSummarized. bModuleFatalError ⁽¹⁾	One or more modules present in the bus are not functional.
	6	MODULES W/ PARAM. ERROR	tPbusHeadB.tSummarized. bModuleParameterError ⁽¹⁾	One or more modules present in the bus are with parameterization error.
	7	EXCEEDED NUM BYTES	tPbusHeadB.tSummarized. bEx- ceededNumInOutBytes	Indicates that the maximum number of I/O bytes has been exceeded.

Direct Representation		Diagnostics Message	Symbolic Variable DG_NX5110.*	Description
Variable	Tamanho			
Variável				
%QB(n+25)	8	EXCEEDED MAX NUM MODULES	tPbusHeadB.tSummarized. bExceededMaxModules	Indicates that the maximum number of modules has been exceeded.
	9	-	bReserved_9	Reserved.
	10	BUS ERROR	tPbusHeadB.tSummarized. bLocalBusError	Indicates that there is a failure in the local bus.
	11	HARDWARE FAILURE	tPbusHeadB.tSummarized. bHardwareFailure	Indicates that there is a hardware failure in the device.
	12	-	bReserved_12	Reserved.
	13	OTD SWITCH ERROR	tPbusHeadB.tSummarized. bOTDSwitchError	The OTD switch was stuck for more than 20 seconds at least once while the slave was powered. This diagnostics is only cleared when the system is restarted.
	14	ADDRESS MODIFIED	tPbusHeadB.tSummarized. bPbAddrSwitchChanged	Indicates that the slave's PROFIBUS-DP address has been altered.
	15	-	tPbusHeadB.tSummarized. bThermometerFailure	Indicates failure in the internal thermometer.
	16	-	tPbusHeadB.tSummarized. bOverTemperatureAlarm	Indicates the high temperature alarm.
	17	-	tPbusHeadB.tSummarized. bUnderTemperatureAlarm	Indicates the low temperature alarm.
	18	-	tPbusHeadB.tSummarized. bBrownOutReset	Indicates that the device has been restarted due to a power failure.
	19	-	tPbusHeadB.tSummarized. bWatchdogReset	Indicates that the device has been restarted due to a watchdog.
	20	HOT SWAP MODE ERROR	tPbusHeadB.tSummarized. bHotSwapModeError ⁽¹⁾	Informs that there has been an unusual situation in the bus and that the hot swap logic (parameterized by the user) has acted, taking the slave to an Error state.
	21	WRONG SLOT	tPbusHeadB.tSummarized. bWrongSlot	Indicates that the PROFIBUS-DP Head is powered and placed in the wrong bus slot.
22..31	-	tPbusHeadB.tSummarized. bReserved_nn	Reserved.	
%QB(n+29)	DWORD	-	tPbusHeadB.dwModuleNotPresent ⁽¹⁾	Indicates module presence in the respective bus positions.

Table 14: Diagnostics Mapped to Variables

⁽¹⁾The state of these diagnostics is duplicated between tPbusHeadA and tPbusHeadB structures of each PROFIBUS-DP redundant head because they concern the bus. Other diagnostics are specific to each head.

Notes:

Direct Representation Variable: - "n" is the address defined in the field %Q Start Address of Diagnostic Area at the NX5001 configuration screen – tab Module Parameters, at MasterTool IEC XE.

Symbolic Variable: - Some symbolic variables are used to access diagnostics. These diagnostics are stored in direct representation variables, so the AT directive is used to map the symbolic variables to them. The AT directive is a reserved word at MasterTool IEC XE that declares diagnostics automatically in symbolic variables. All diagnostics mapped automatically to symbolic variables are found at the Diagnostics object.

7. Maintenance

7.1. Module Diagnostics

One of the features of the Nexto Series is the generation of irregularities diagnostics such as failures, errors or operating modes, enabling the operator to easily identify and solve problems that may happen to the system.

NX5110 and NX5210 modules have an LCD with status and other useful information such as: Operation Mode with network redundancy enabled, IP address of the Ethernet interface, Sync/Freeze mode indication. There's also the DG LED to provide diagnostics about the interface and the PROFIBUS network and the WD LED to signal the occurrence of a watchdog event.

7.1.1. Graphical Display

The graphic display available in this product has an important tool for the process control, as through it is possible to recognize possible error conditions, active components or diagnostics presence. Besides, all diagnostics including the I/O modules are presented to the user through the graphic display. For further information regarding the diagnostic key utilization and its visualization see [One Touch Diag](#) section.

On figure below, it is possible to observe the available characters in this product graphic display and, next, its respective meanings.

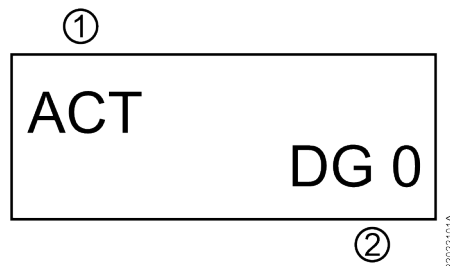

Figure 22: Graphical Display

Legend:

- 1. Indication of the state of operation of the head. For more details on this indication, see section [PROFIBUS-DP Head States](#).
- 2. Indication of the number of active diagnoses in the head. If the number displayed is different from 0 (zero), there are active diagnoses in the head. For more details on viewing the two same graphical displays, through the diagnostics key, see section [One Touch Diag](#).

7.1.2. One Touch Diag

This is another innovative resource present in the Nexto Series. With this new concept, the user can verify the diagnostics of the NX5110, or any other module present in the bar, directly in the graphic display of the header (without diagnostic codes) with just a single press on the diagnostic button of the respective module. "OTD" is a powerful tool that can be used offline (without a supervisory program or programmer), making the troubleshooting process faster and more efficient.

More information about this resource can be found in the Nexto Series User Manual (MU214600).

Figure below shows the PROFIBUS-DP Head switch placement:

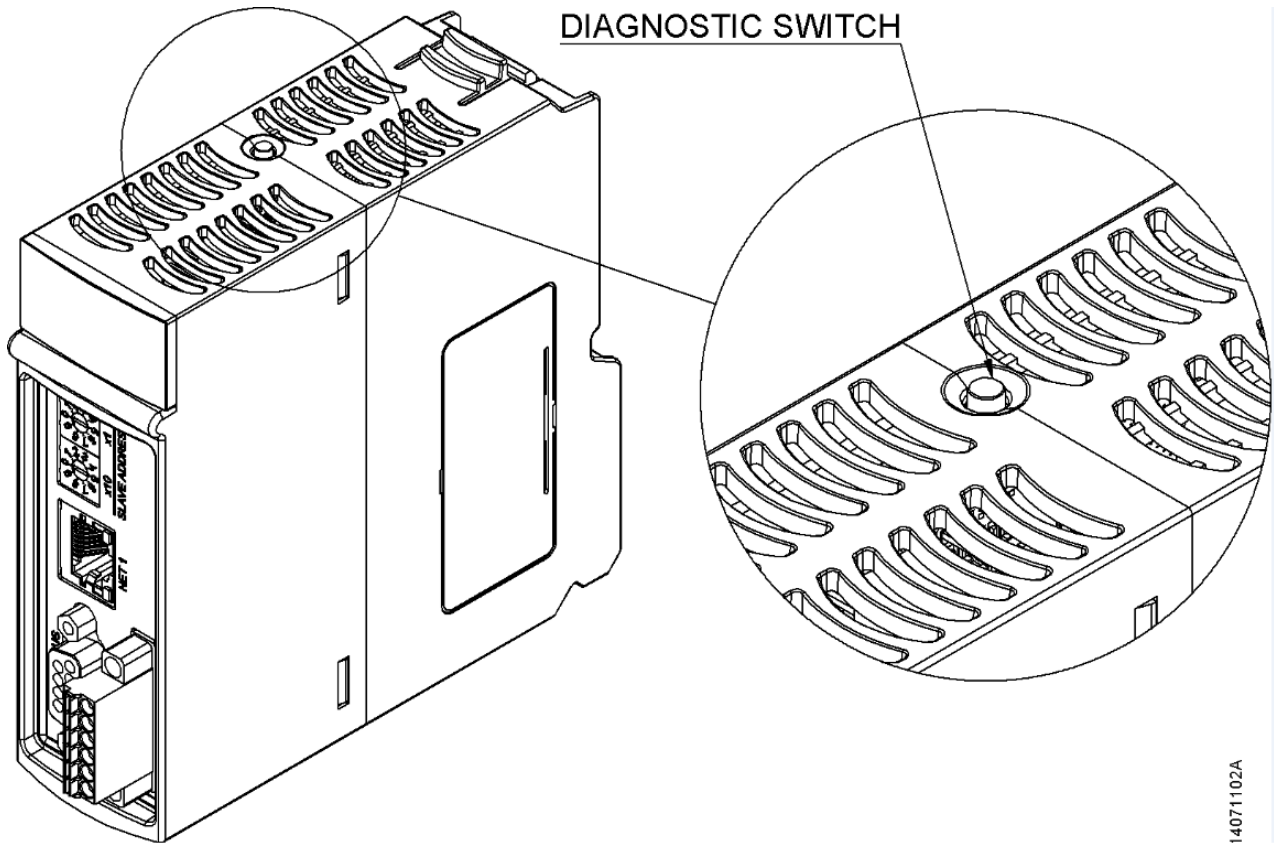

Figure 23: Diagnostic Switch

14071102A

With a single short press, the module starts showing the bus diagnostics (when active, otherwise it shows the “NO DIAG” message). All diagnostics will be shown through messages at the Head’s LCD. This process is executed twice and it is automatic, so the user only has to execute the first short press and the Head is responsible for showing the diagnostics. The diagnostics of other modules present in the bus are also shown on the Head’s LCD by a short press in their diagnostics switch, in the same presentation model of the Head diagnostics.

Figure below shows the process starting with the short press, with the conditions and the times presented in smaller rectangles. It is important to stress a single diagnostic may use more than one screen to present the whole message, so the specified time in the flowchart below is valid for each screen.

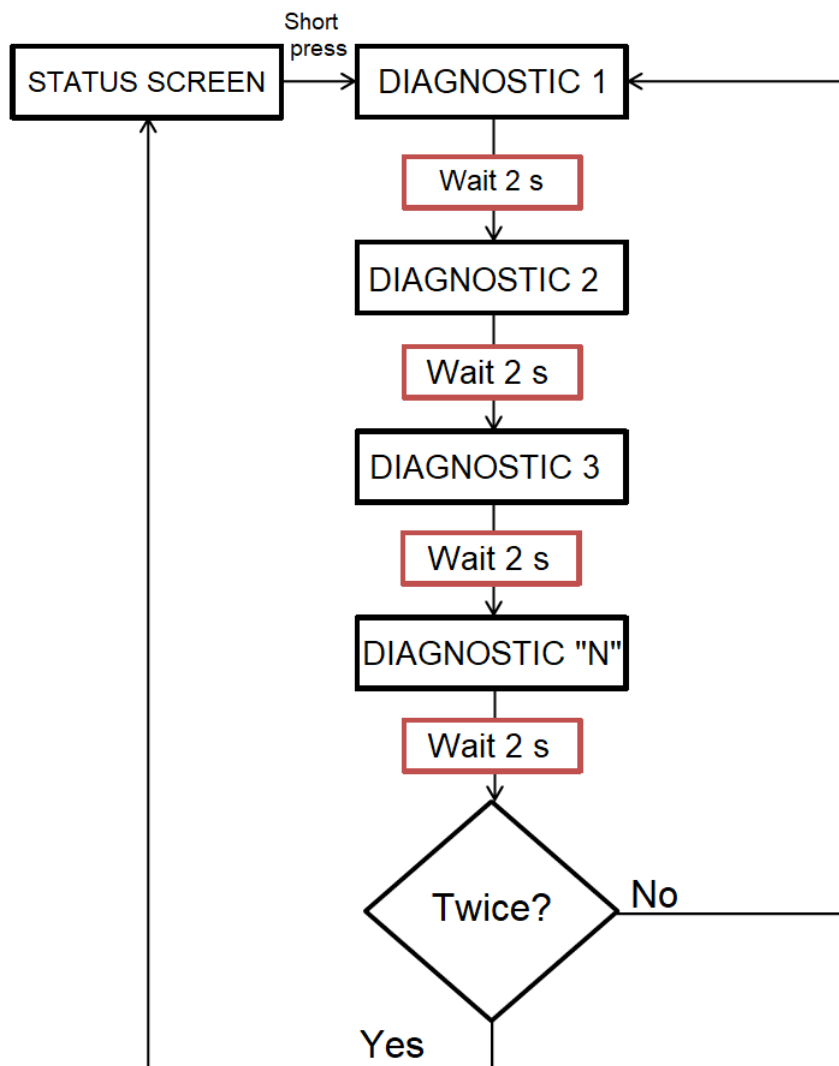

Figure 24: Diagnostics Visualization

7.1.3. Diagnostics LEDs

PROFIBUS Heads NX5110 and NX5210 have an LED for diagnostics indication (LED DG) and an LED for watchdog event indication (LED WD).

Table below and Table 7-2 describe each LED's state:

7.1.3.1. DG (Diagnostic)

Green	Red	Description	Causes	Priority
ON	OFF	Cyclic data are exchanged with the master.	Communication with PROFIBUS-DP master has been established.	5 (Low)
Blink 2x	OFF	Modules in the bus with diagnostics.	Some module, including the Head, has an active diagnostic.	4
Blink 4x	OFF	No configuration.	- PROFIBUS-DP master still hasn't sent the parameterization and configuration	3
OFF	PBlink 1x	Configuration Error or Hardware Error.	Configuration/Parameterization Error. See the diagnostics structure.	2
OFF	ON	No activity in the PROFIBUS network.	- Defective PROFIBUS-DP network cable.	1

Green	Red	Description	Causes	Priority
			- Disconnected PROFIBUS-DP network cable. - Error in PROFIBUS-DP termination	
OFF	OFF	Hardware Error in the Head.	- Fatal hardware fault. - Memory error in PROFIBUS-DP coprocessor.	0 (High)

Table 15: DG LED Diagnostics

7.1.3.2. WD (Watchdog)

Green	Red	Description	Causes	Priority
OFF	OFF	No watchdog indication	Normal operation	3 (Low)
OFF	Blink 1x	Software watchdog	Software watchdog	2
OFF	ON	Hardware watchdog	Damaged Module	1 (High)

Table 16: WD LED Diagnostics

Notes:

Software Watchdog: To remove the watchdog application, the device must be reset. This watchdog happens when the PROFIBUS-DP execution time is larger than the watchdog configured time.

Hardware Watchdog: In order to reset any watchdog indication, as in the WD LED or in the tDetailed.Reset.bWatchdogReset variable, the module must be disconnected from the power supply.

7.1.4. WEB Diagnostics

Besides the previously presented features, Nexto Series brings to the user an innovating access tool to the system diagnostics and operation states through a WEB page. The utilization and dynamics is very intuitive and facilitates user operation. The use of a supervisory system can be replaced when it is restricted to system status verification.

To access the desired PROFIBUS-DB Head WEB page, just use a standard browser (Internet Explorer 7 or above, Mozilla Firefox 3.0 or above and Google Chrome 8 or above) and type the Head's IP address at the address bar (e.g. 192.168.1.1).

First, the PROFIBUS-DP Head information is presented, as in Figure below:

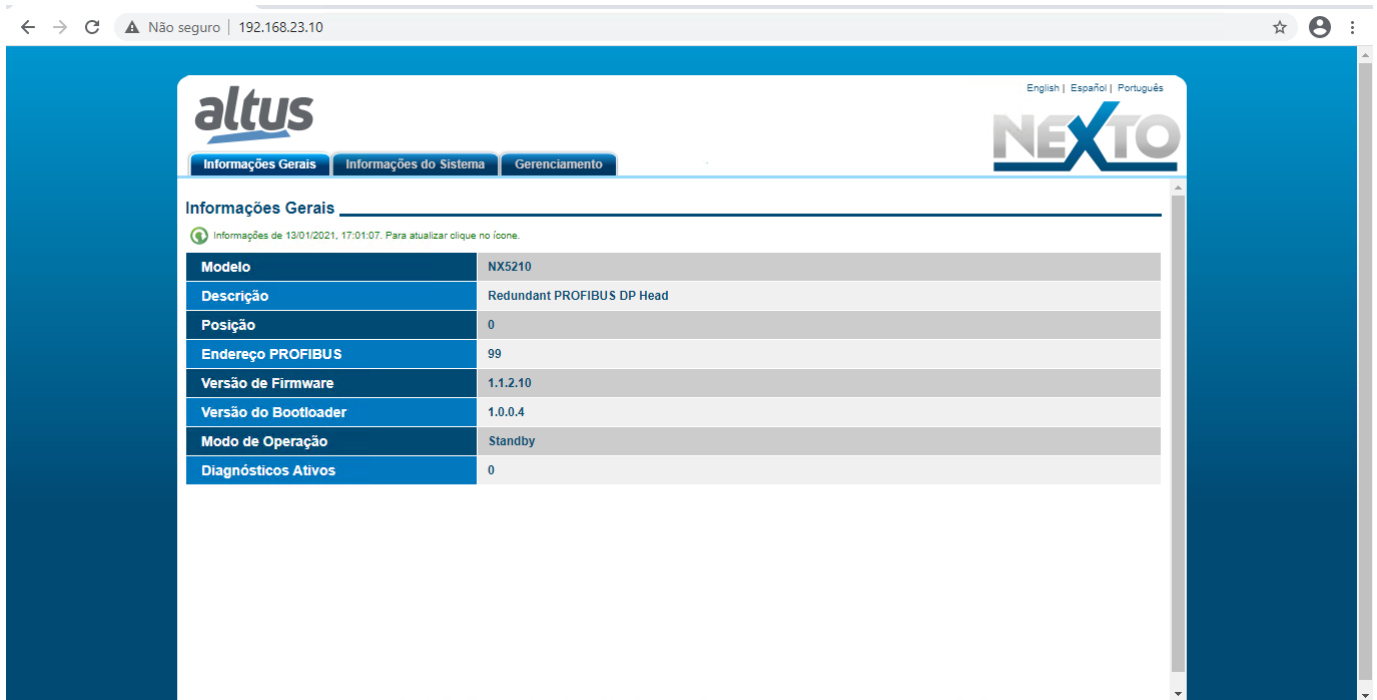

Figure 25: Start Screen

There's also the System Overview tab, where the user can see Diagnostics and Status information on the PROFIBUS-DP Head. The Diagnostics section shows the active Diagnostics of the PROFIBUS-DP Head, as shown in Figure below.

ATTENTION

When a PROFIBUS Head is restarted and an application exception happens at the startup, the diagnostics are not valid. It is necessary to fix the problem that generates the application exception for the diagnostics to be updated.

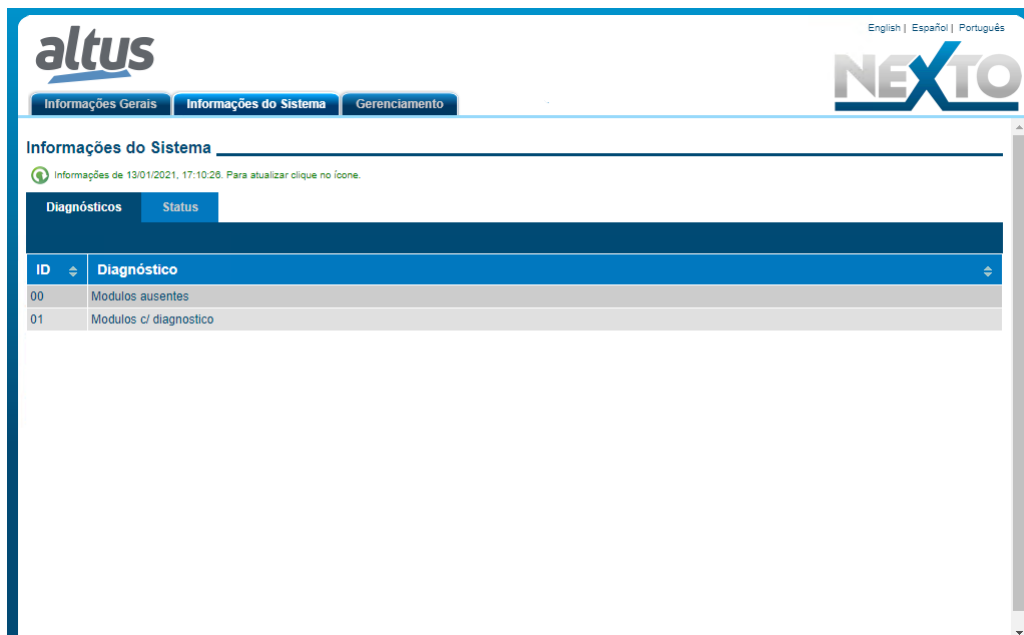

Figure 26: System Diagnostics

The Status section shows the state of all detailed diagnostics, as shown in Figure below:



Figure 27: System Status

The user can also choose between three language options: Portuguese, English and Spanish. The options are in upper right menu.

The Management tab allows the IP address configuration at the Network Configuration section, where the current configuration is seen, and also a button to enable its editing, as shown in Figure below.

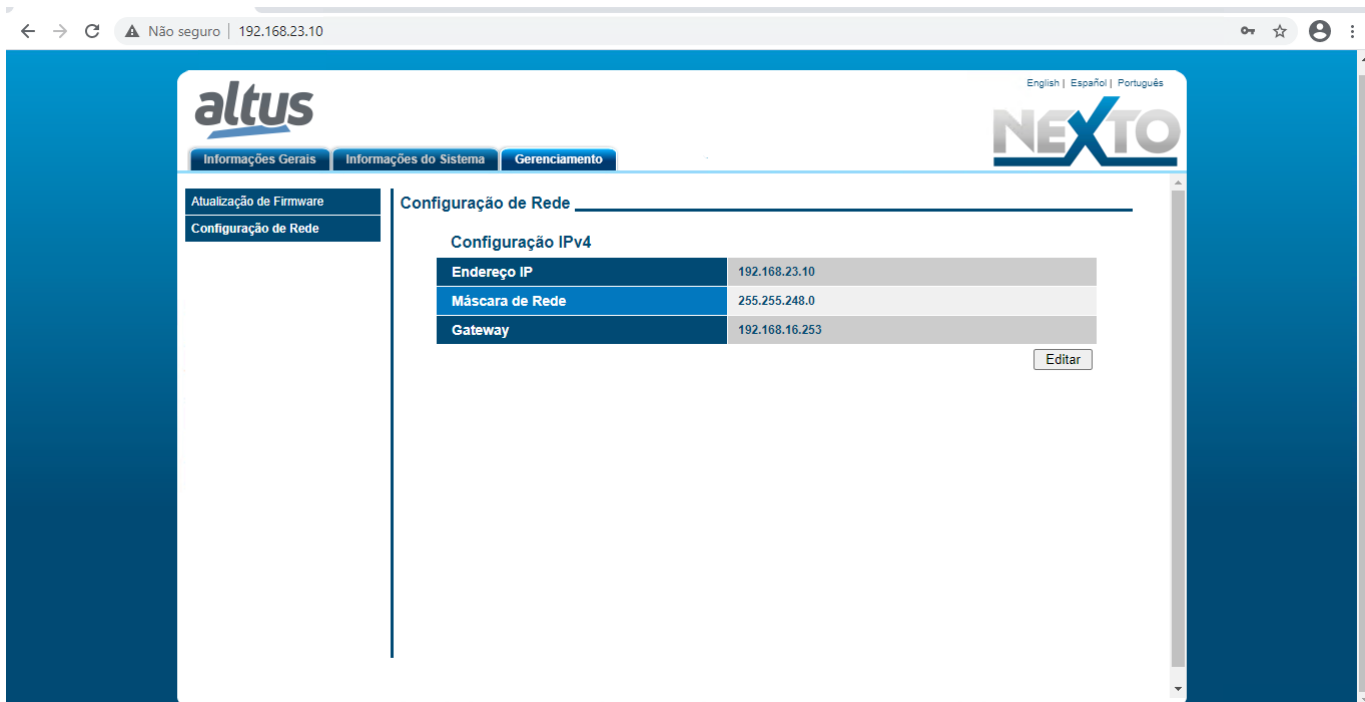

Figure 28: Network Configuration

The Firmware Update section is restricted to Altus' internal usage.

7.2. Preventive Maintenance

- It must be verified, each year, if the interconnection cables are connected firmly, without dust accumulation, mainly the protection devices
- In environments subjected to excessive contamination, the equipment must be periodically cleaned from dust, debris, etc

The TVS diodes used for transient protection caused by atmospheric discharges must be periodically inspected, as they might be damaged or destroyed in case the absorbed energy is above limit. In many cases, the failure may not be visual. In critical applications, is recommendable the periodic replacement of the TVS diodes, even if they do not show visual signals of failure.